



3182



 **WARNING: CHOKING HAZARD.**
Toy contains small parts and a small ball.
Not for children under 3 years.



4

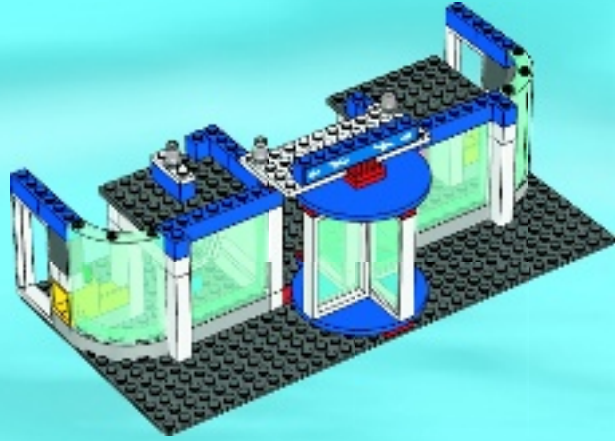

5

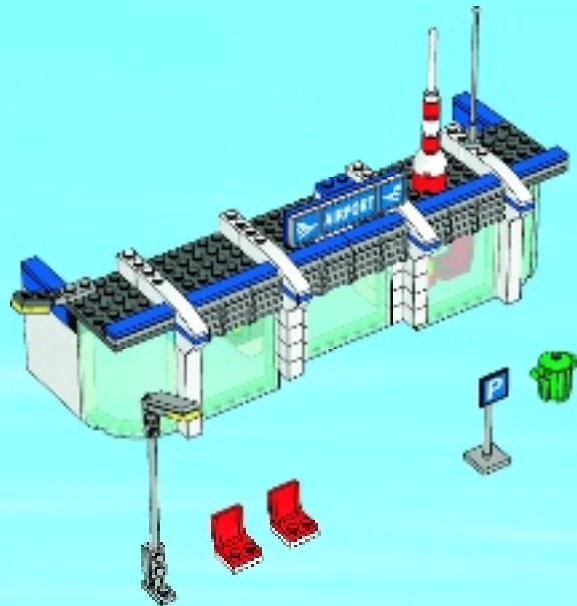



+



4

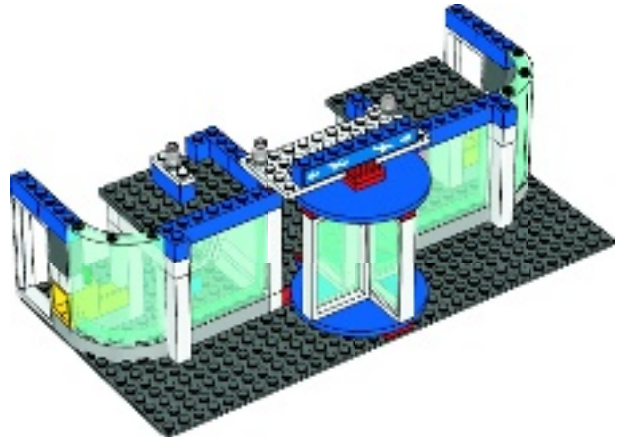

1

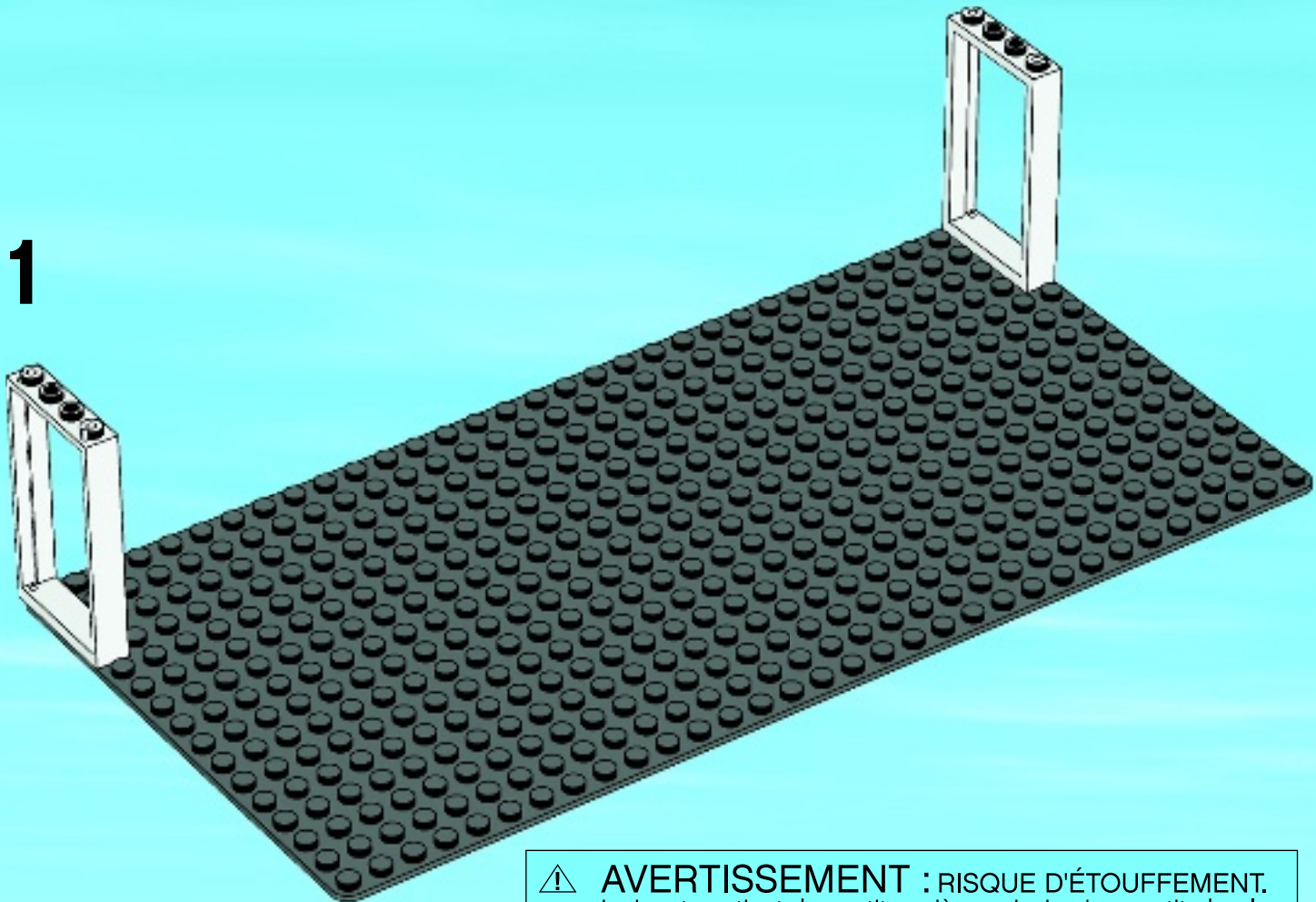

AVERTISSEMENT : RISQUE D'ÉTOUFFEMENT.
Le jouet contient des petites pièces ainsi qu'une petite boule.
Il ne convient pas aux enfants de moins de 3 ans.



ADVERTENCIA: PELIGRO DE ASFIXIA.
Juguete que contiene partes pequeñas y una pelota pequeña.
No recomendado para niños menores de 3 años.

2

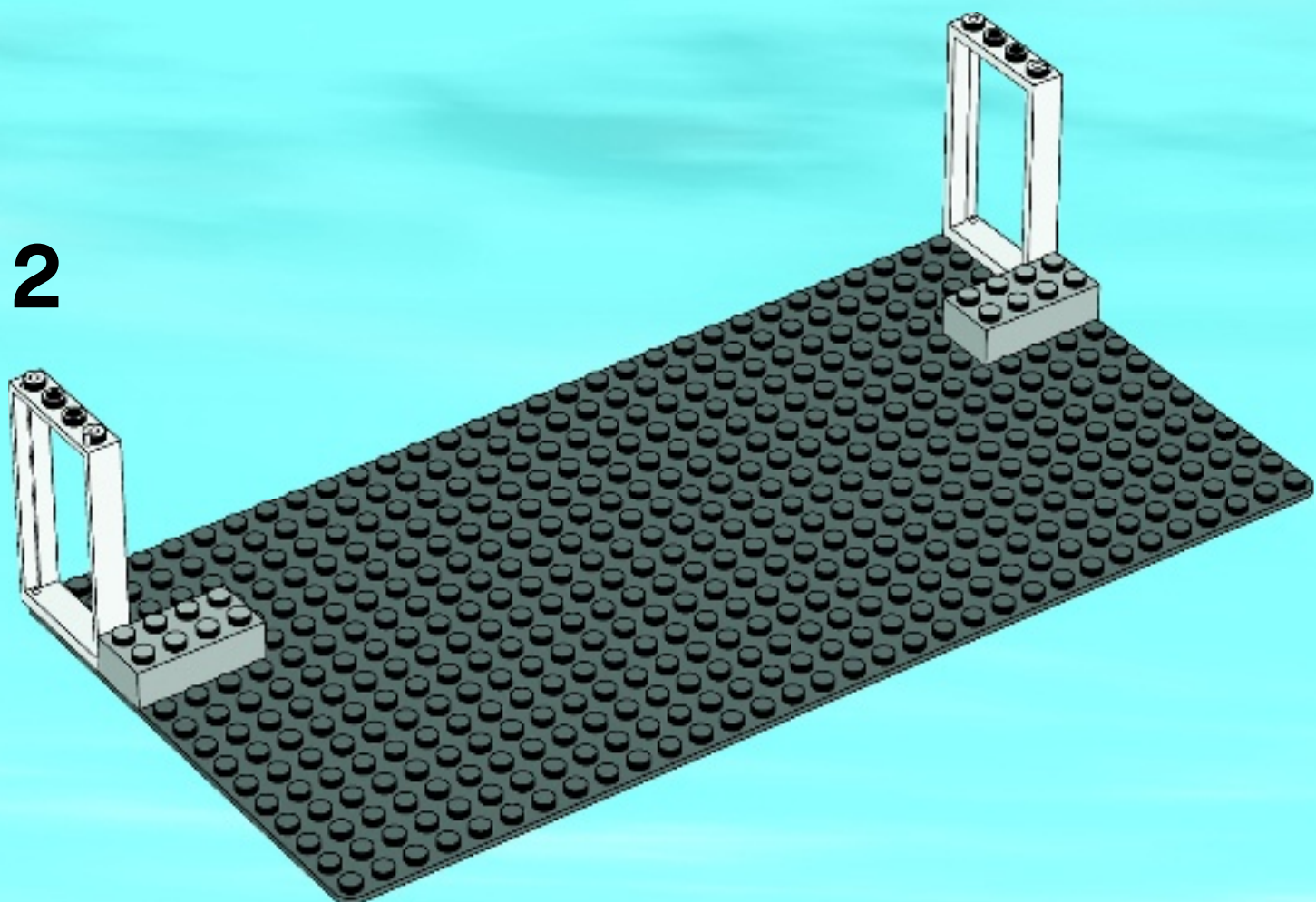

3

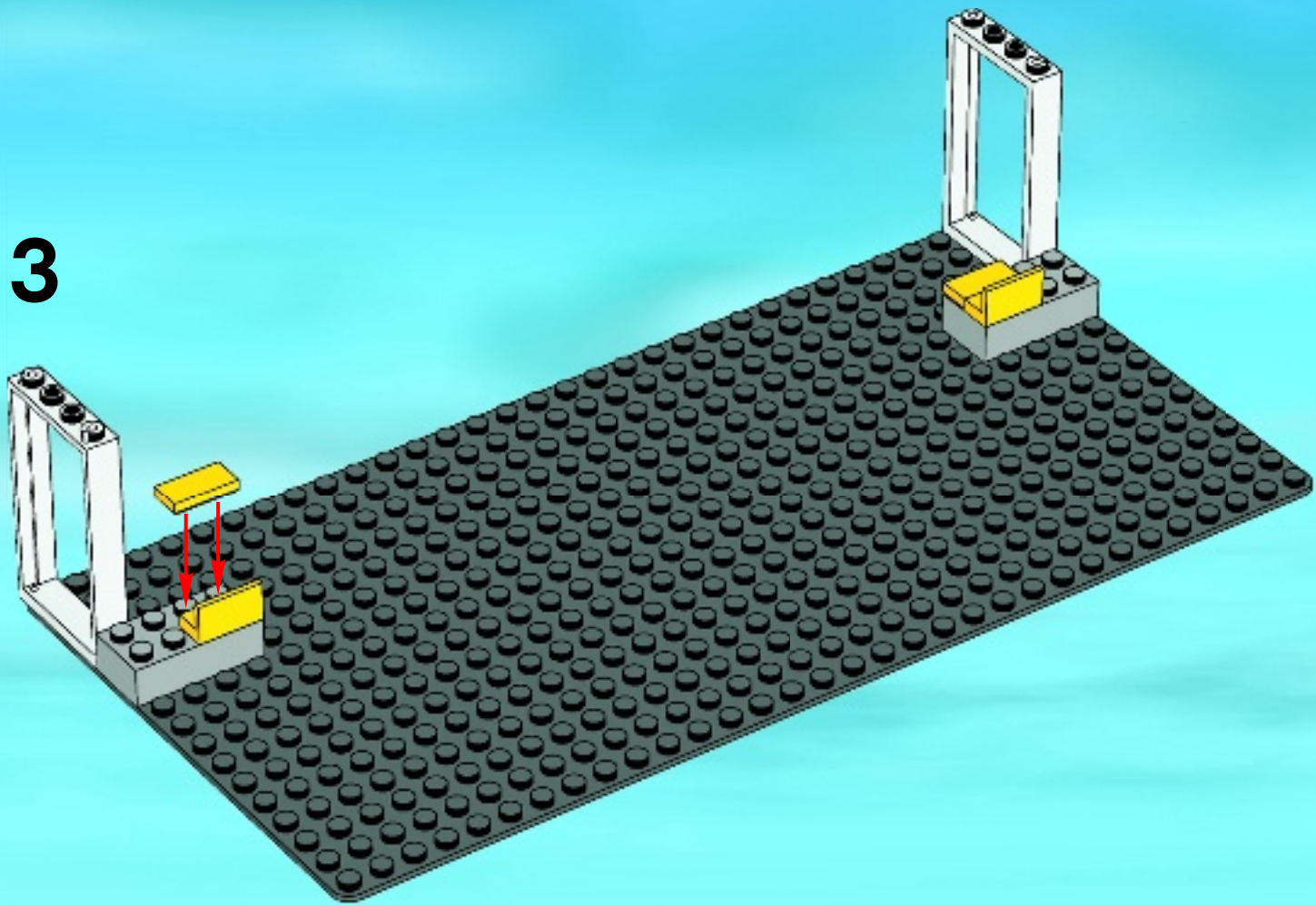

4

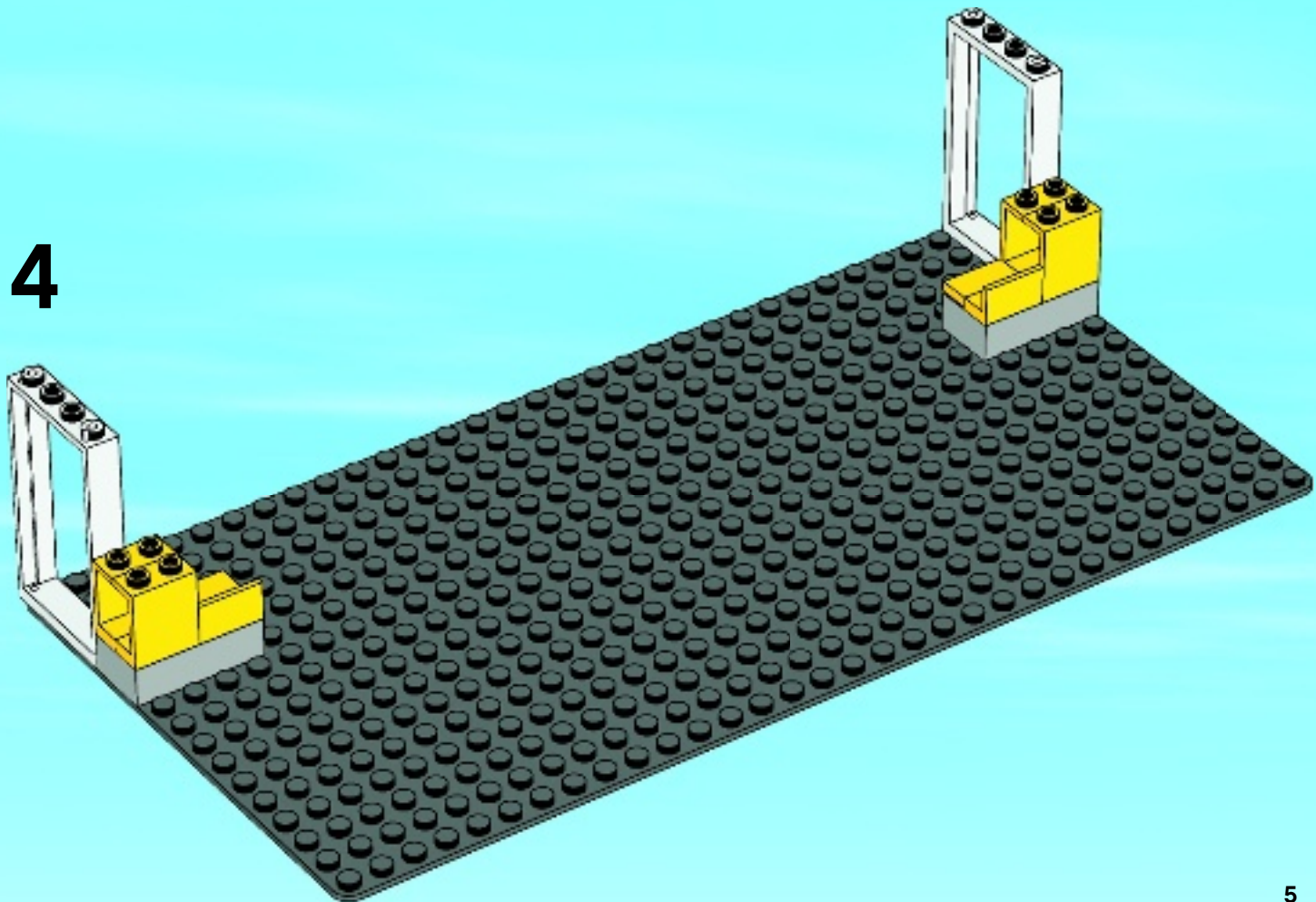

5

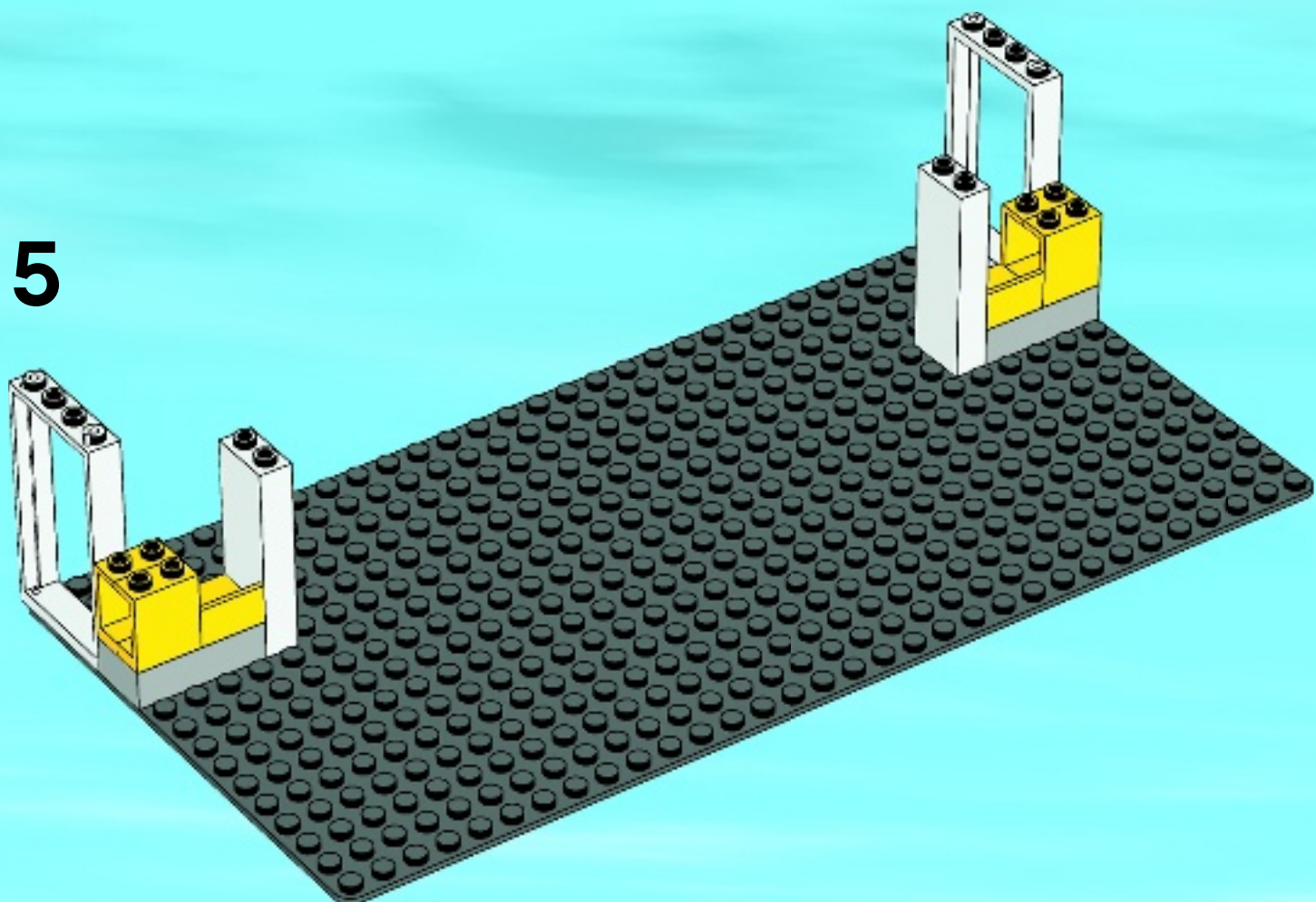

6

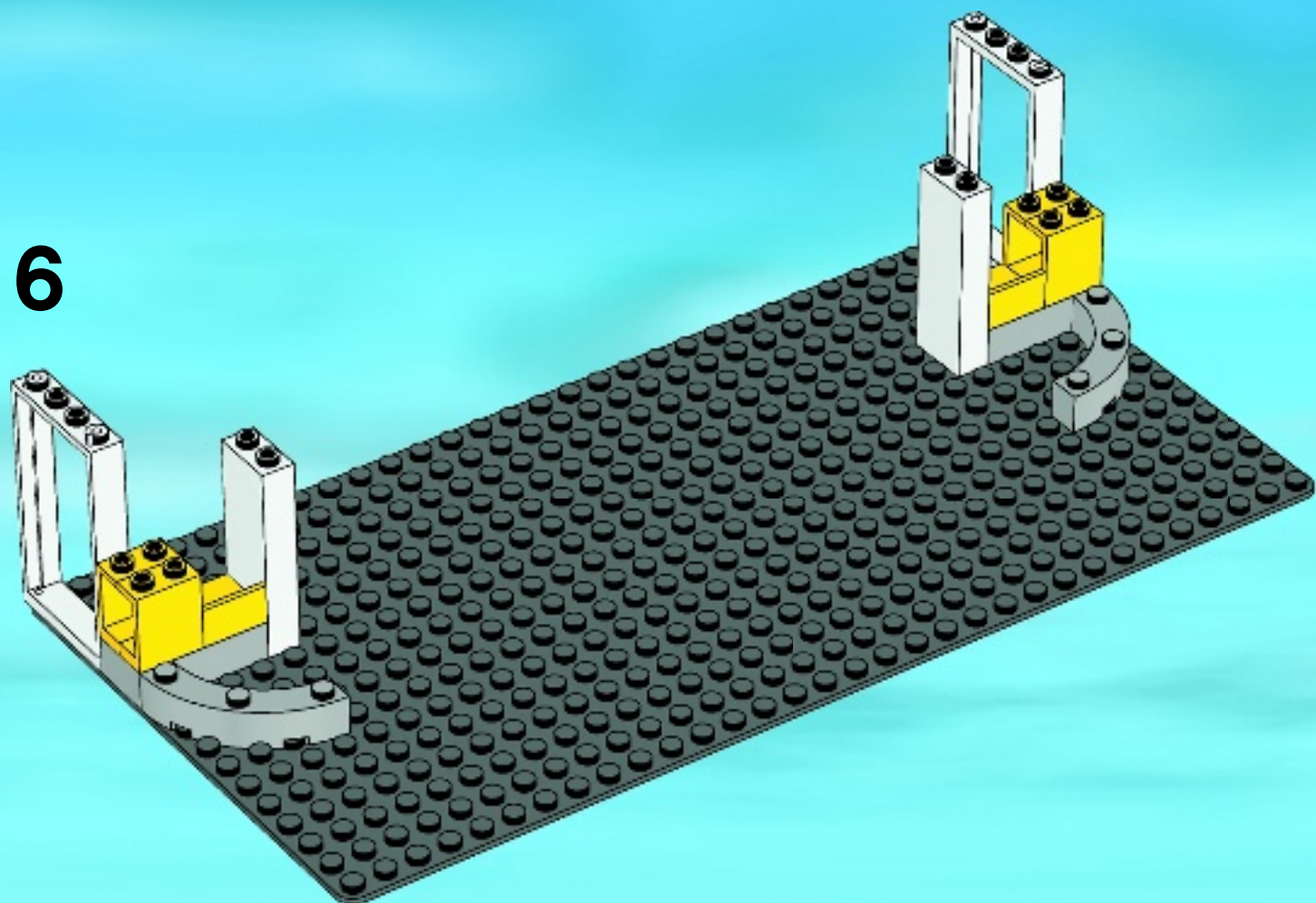

7

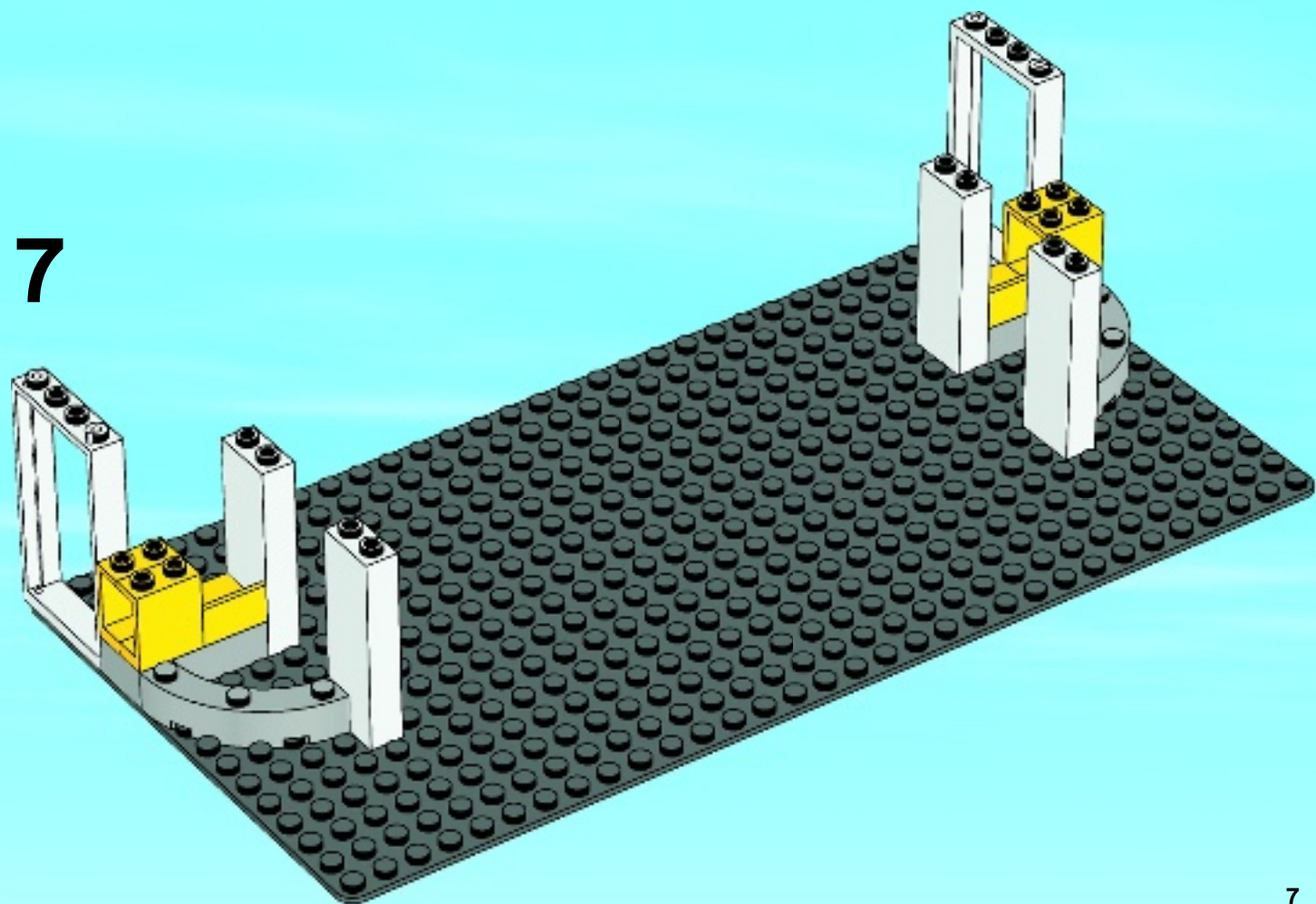

12

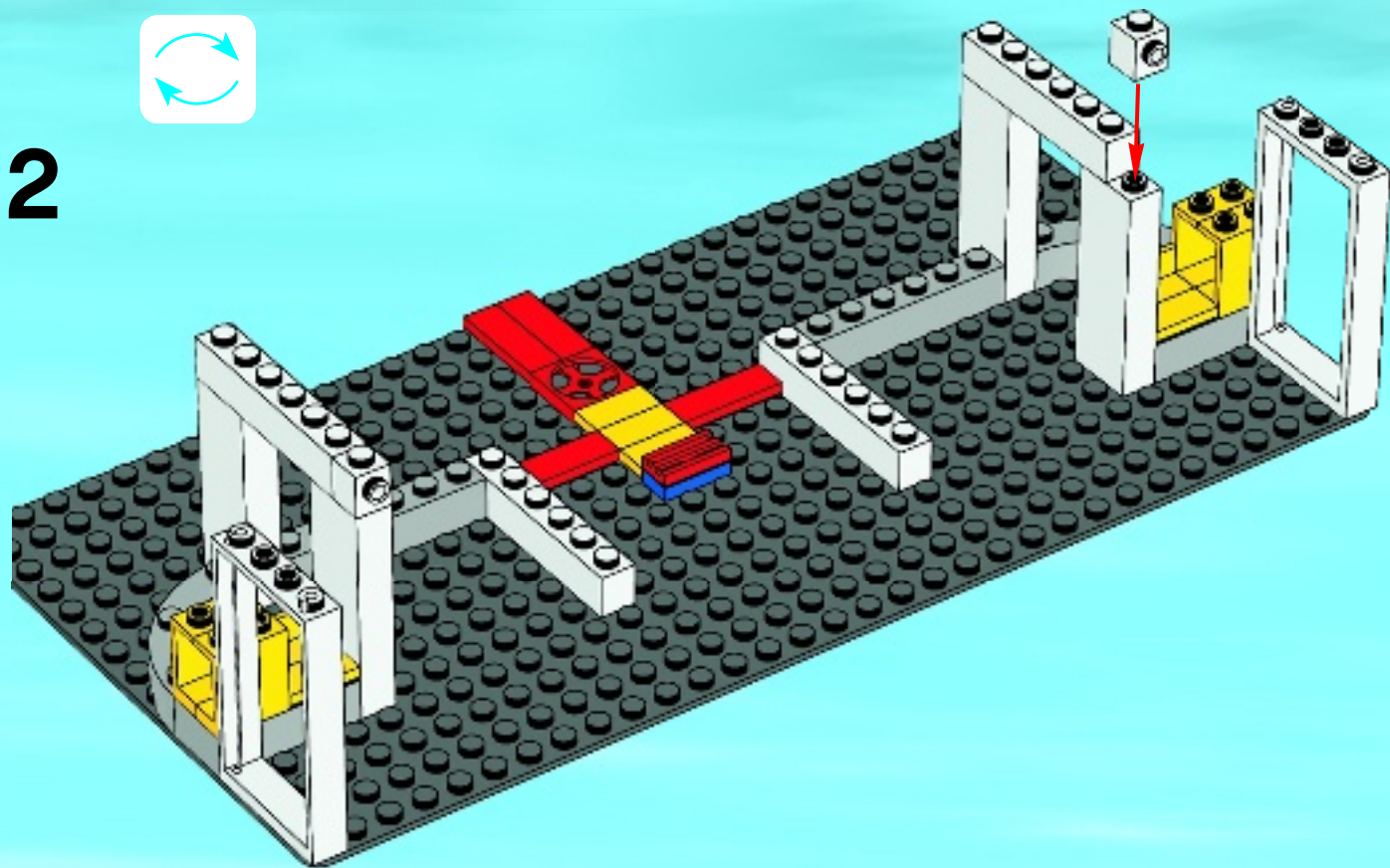

1



2

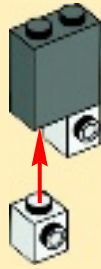

3



4



13

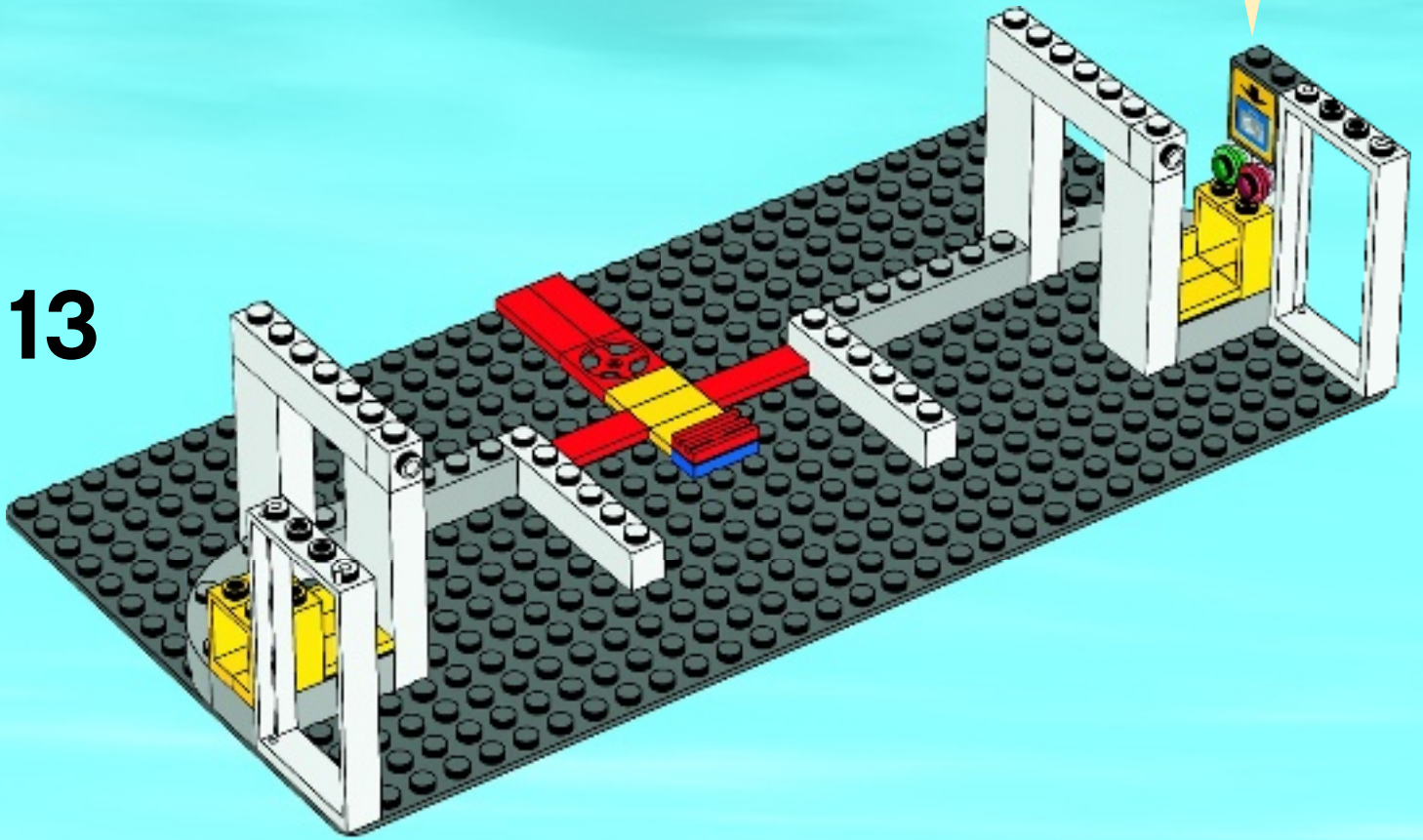

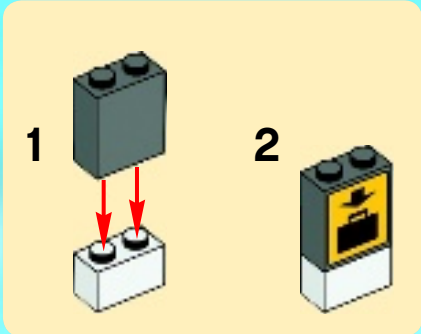

14

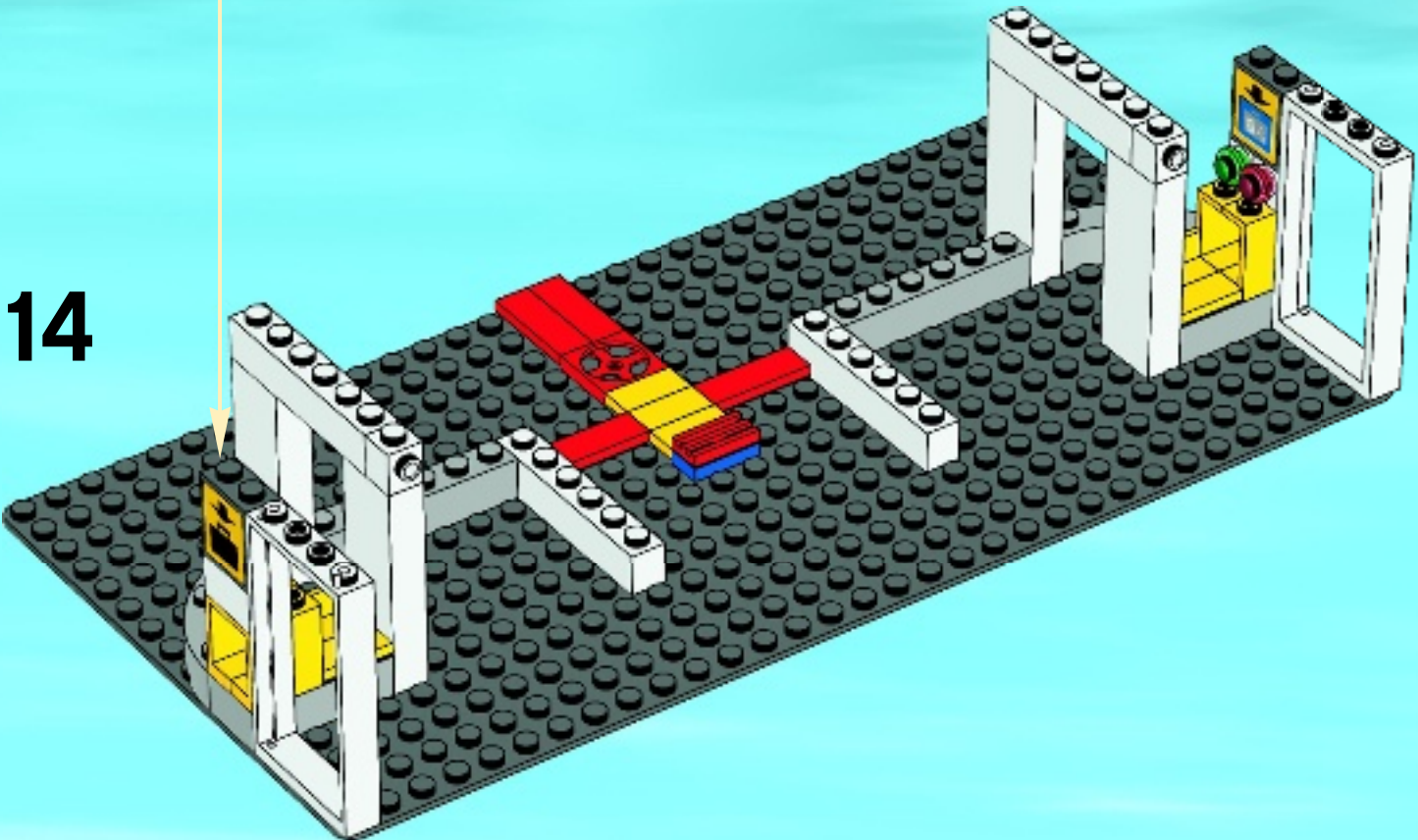



17

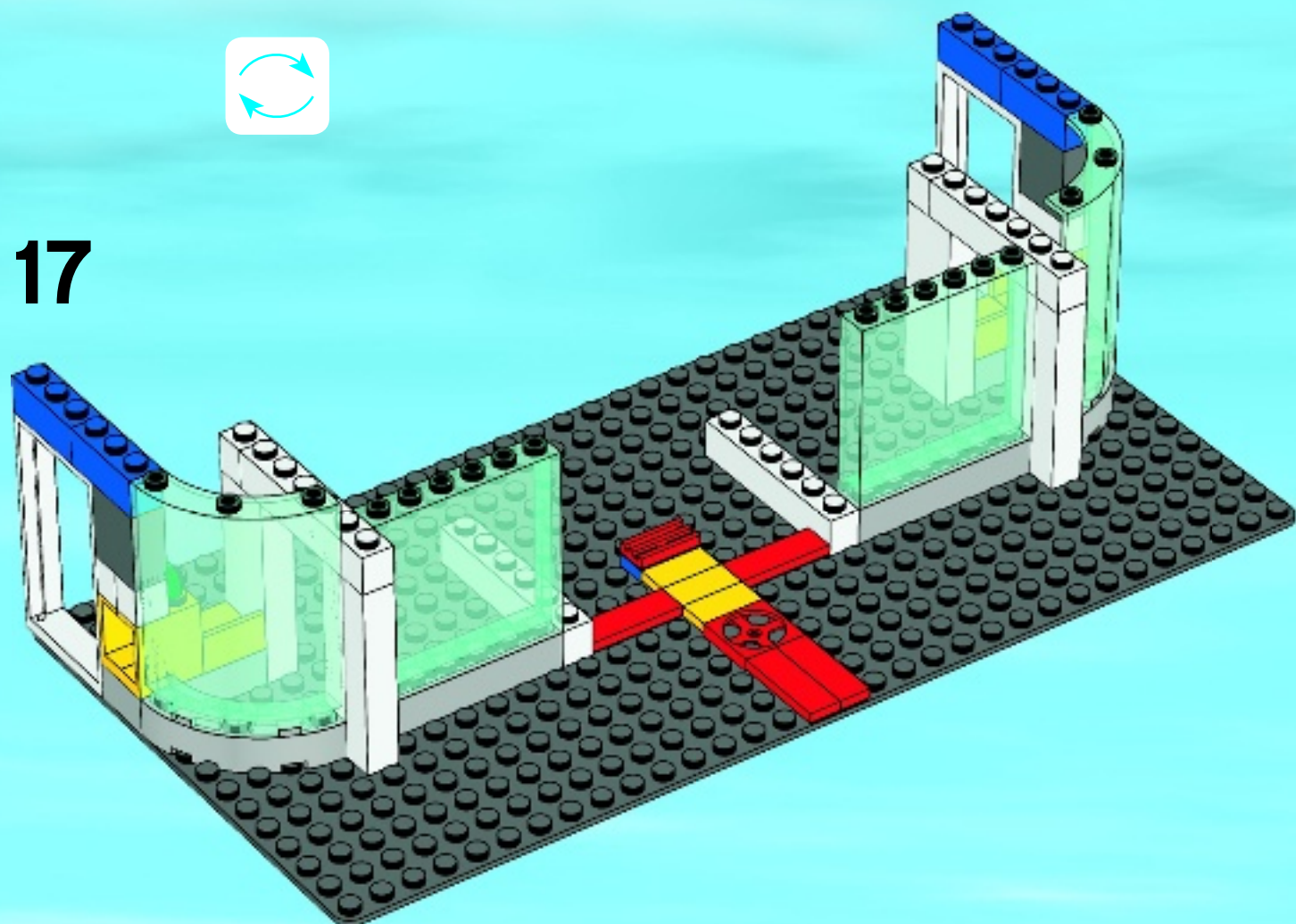

18

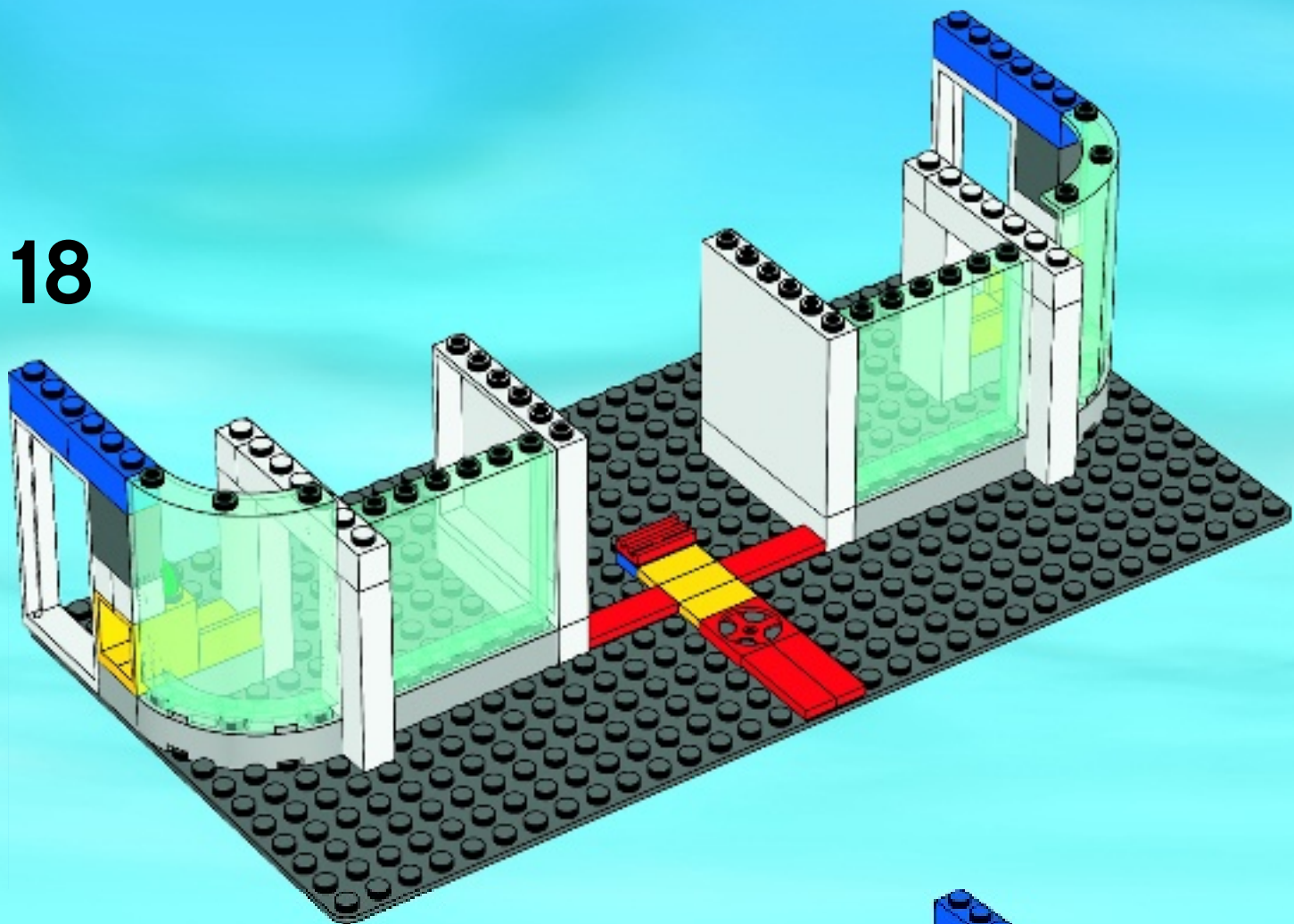

19

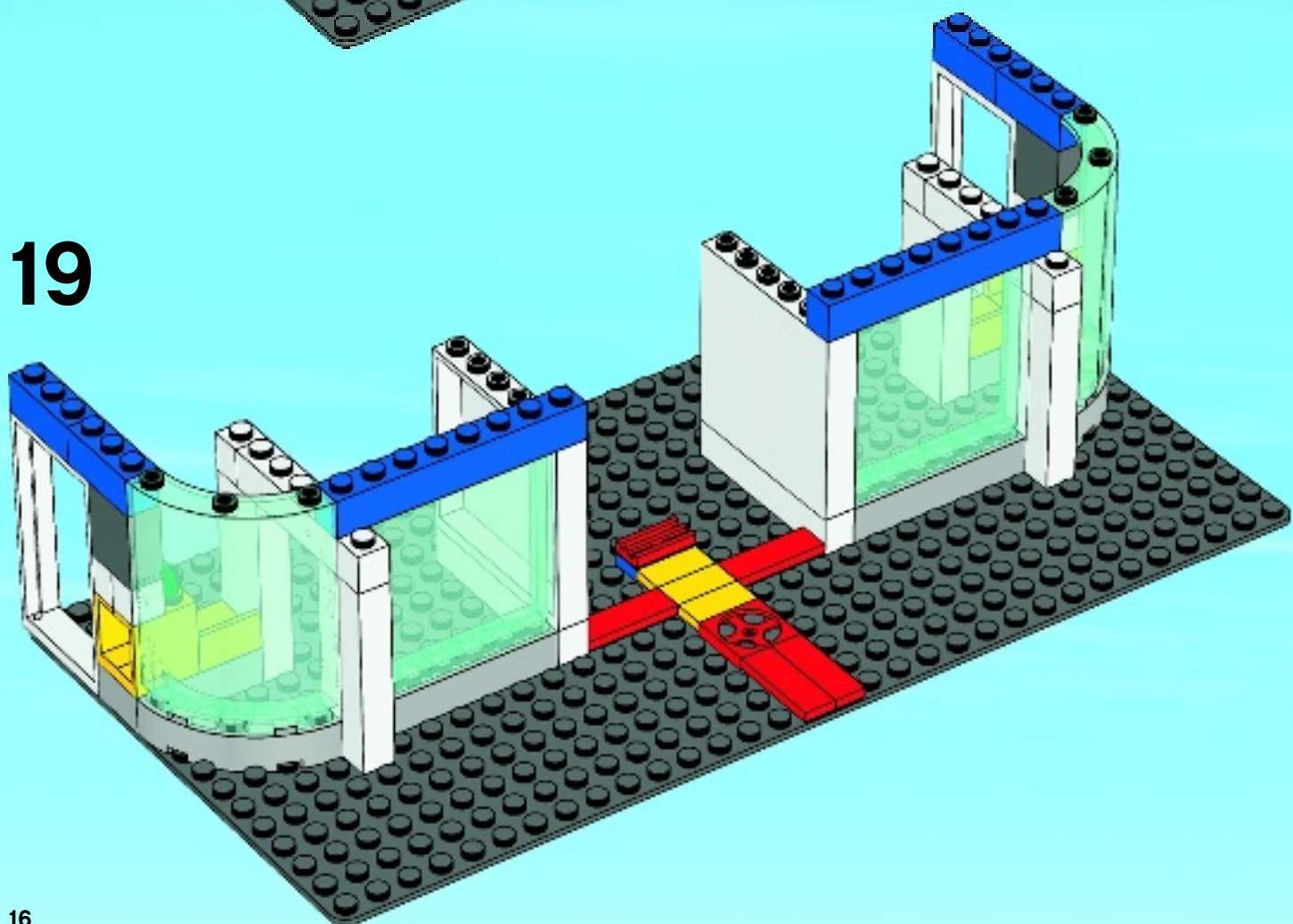

20

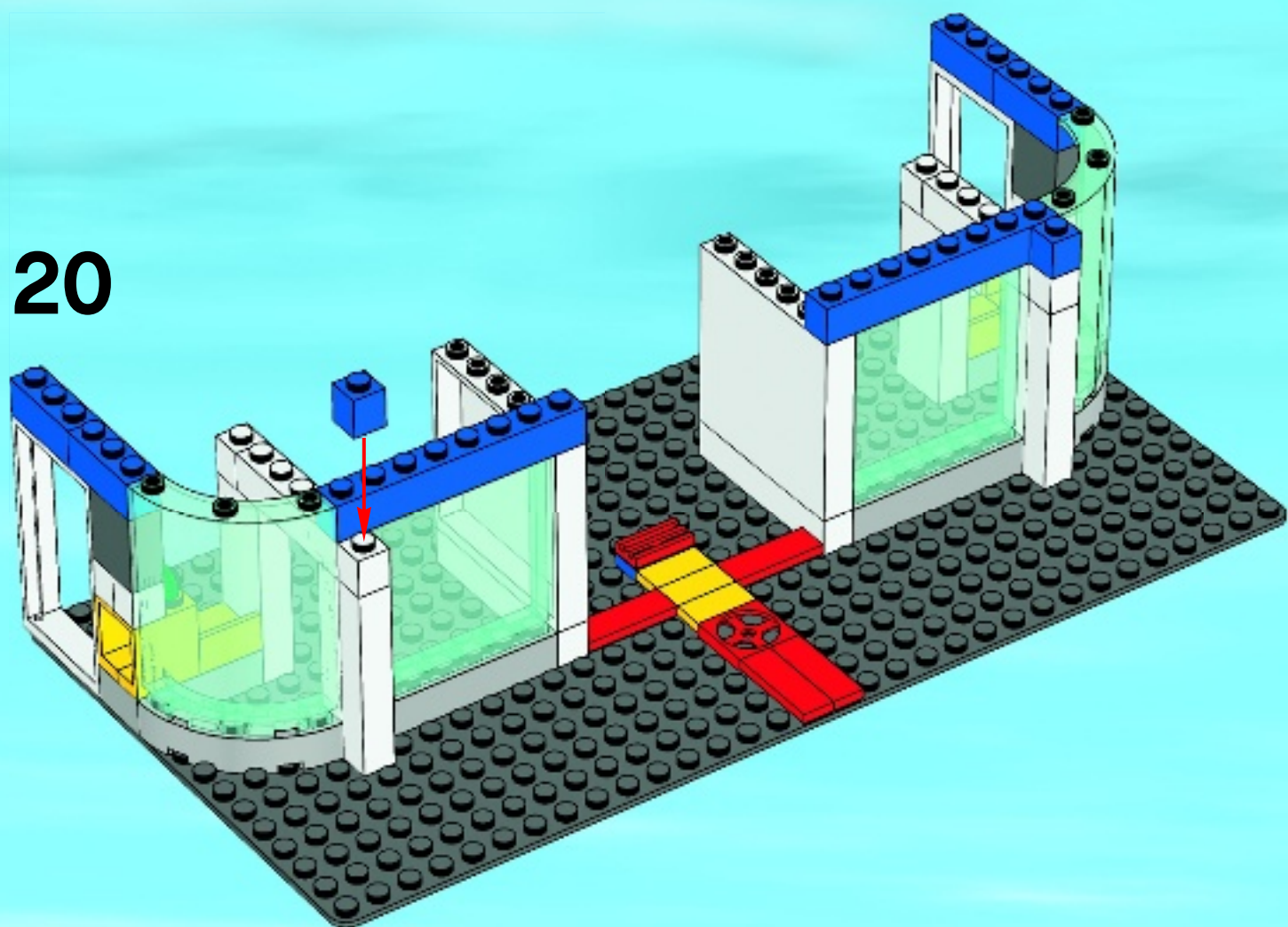



1

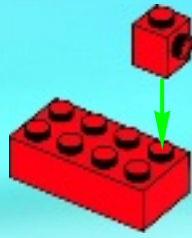

2

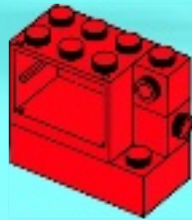

3

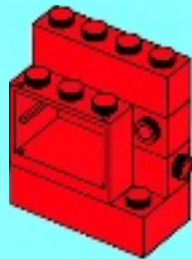

4

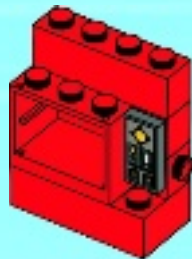

5

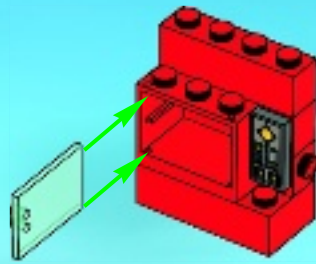

6



7

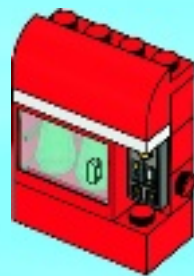

8

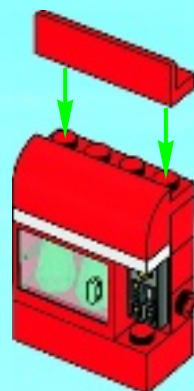



21

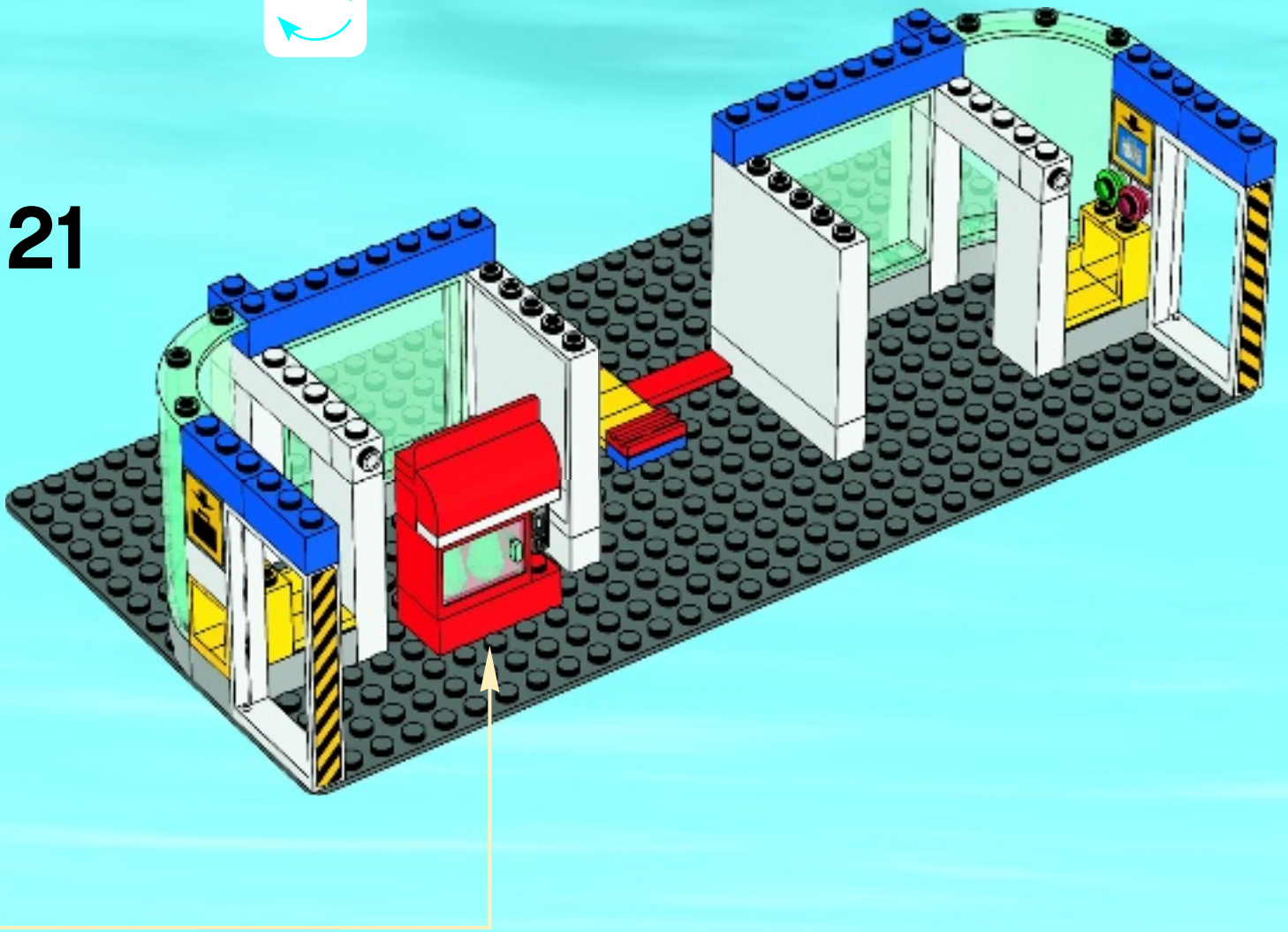

22

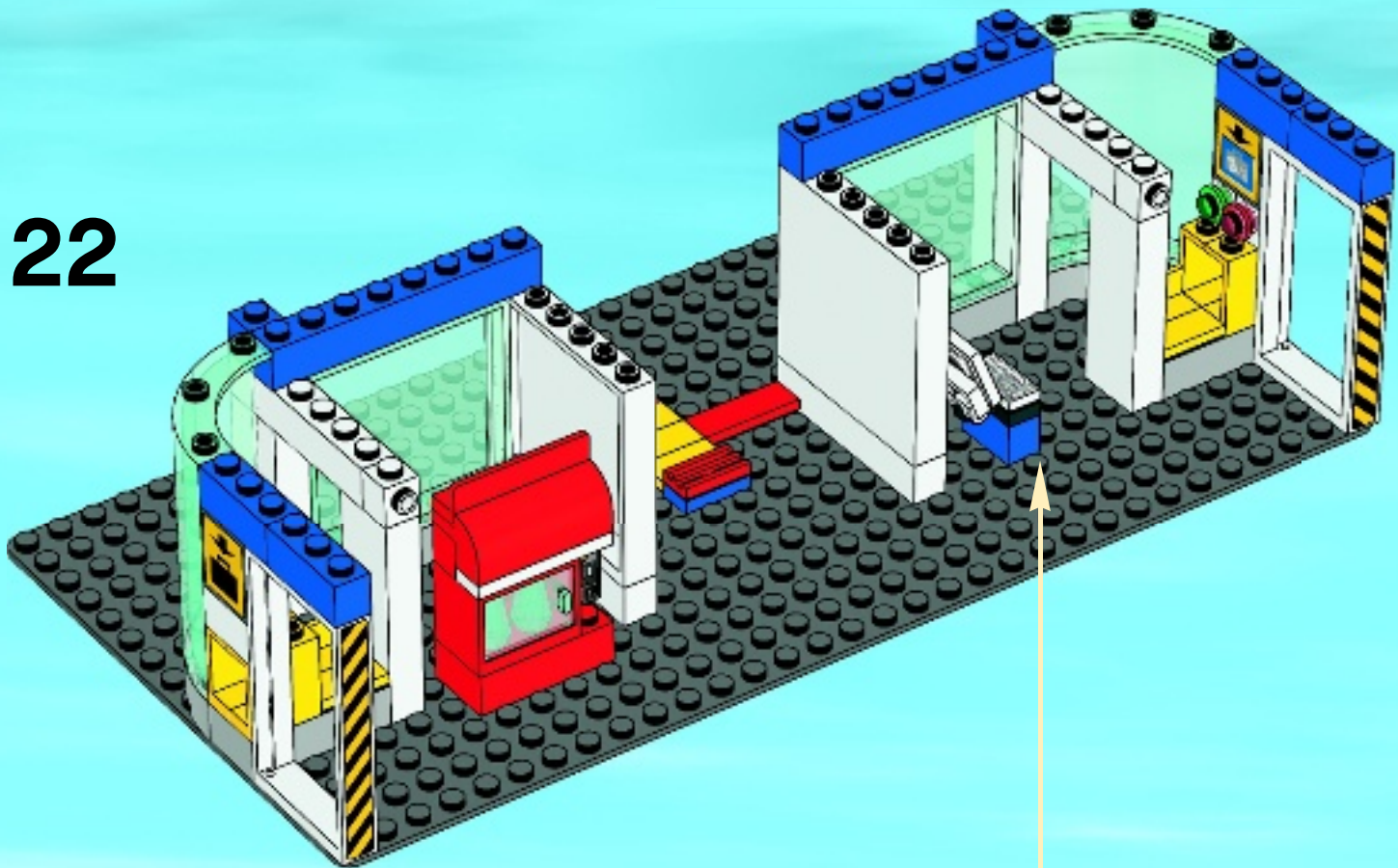

- 1
- 2
- 3
- 4

23

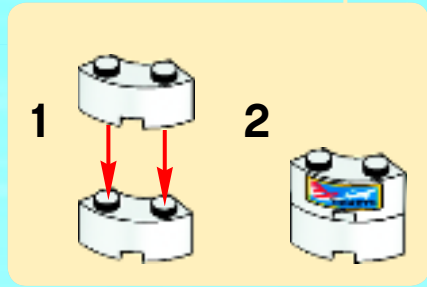
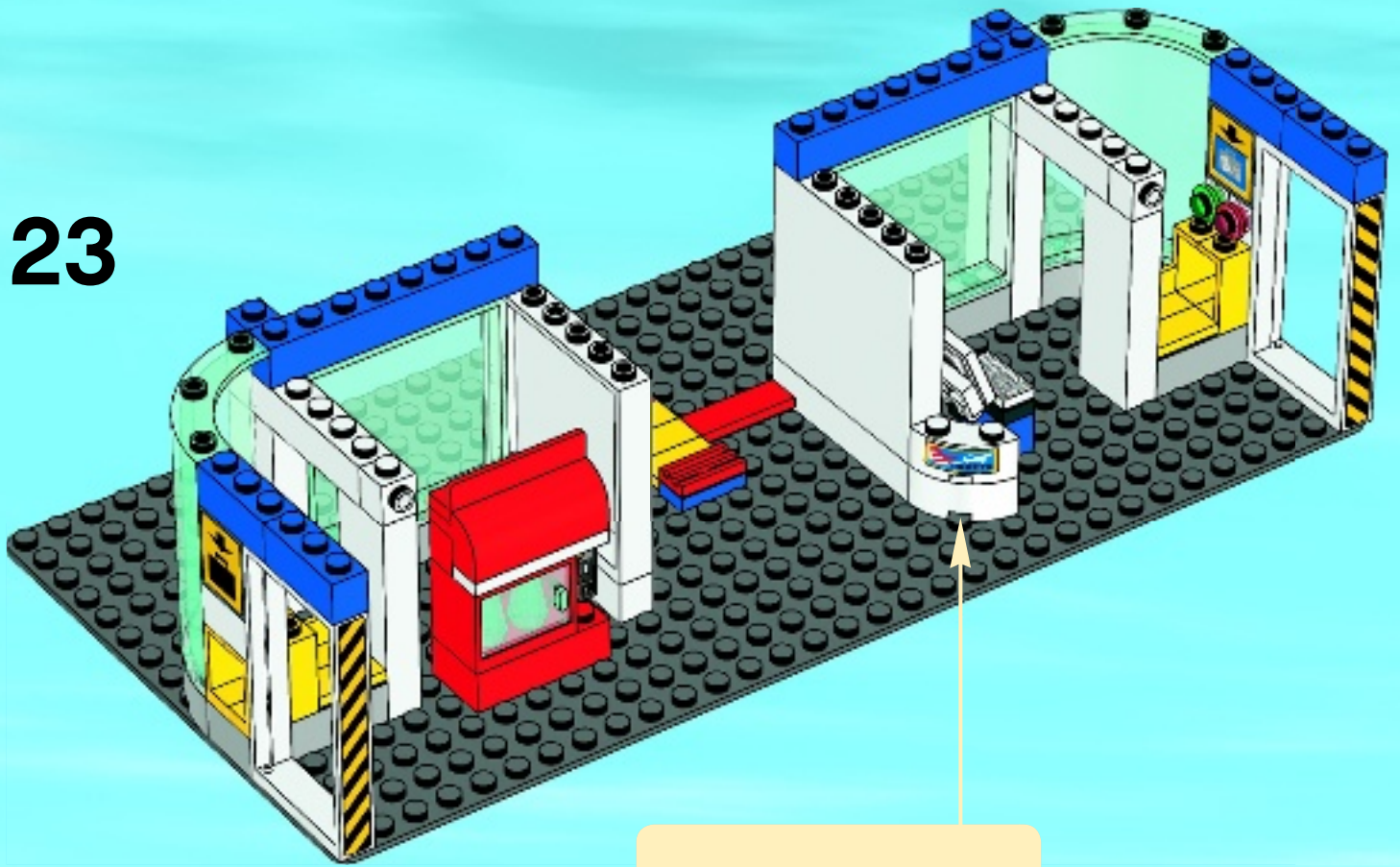

24

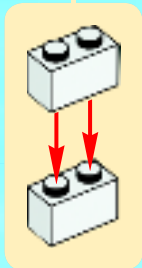
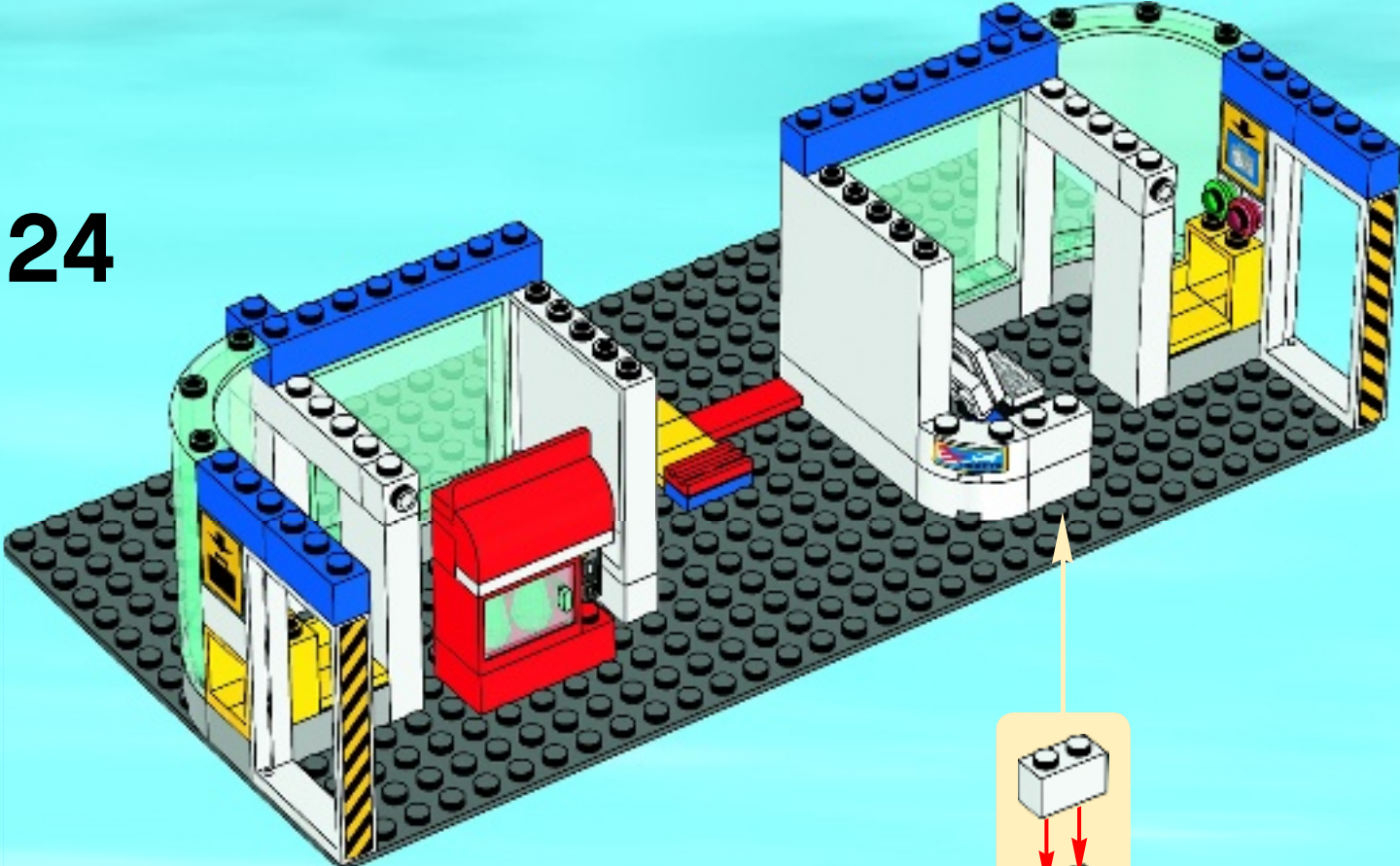

25

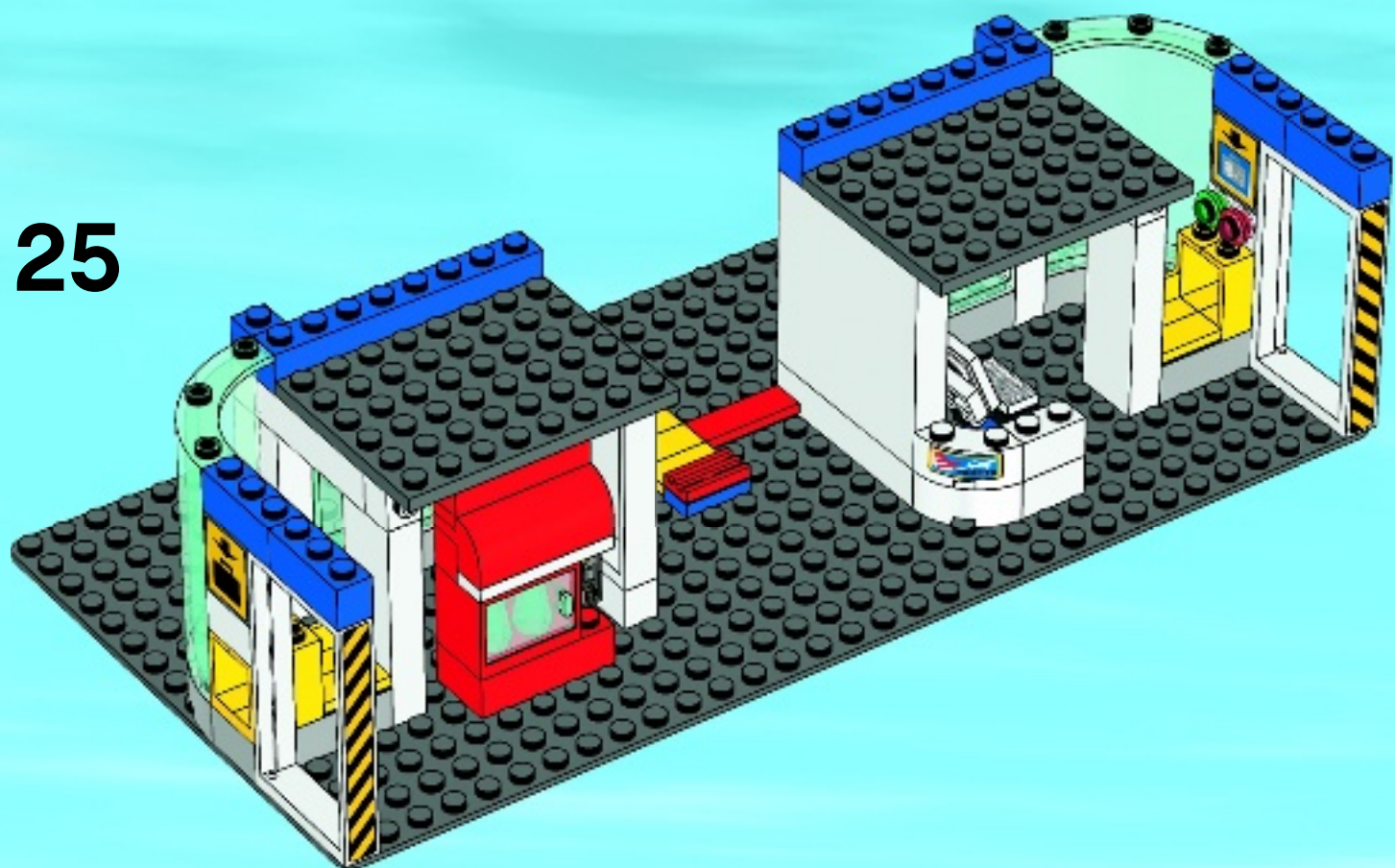

26

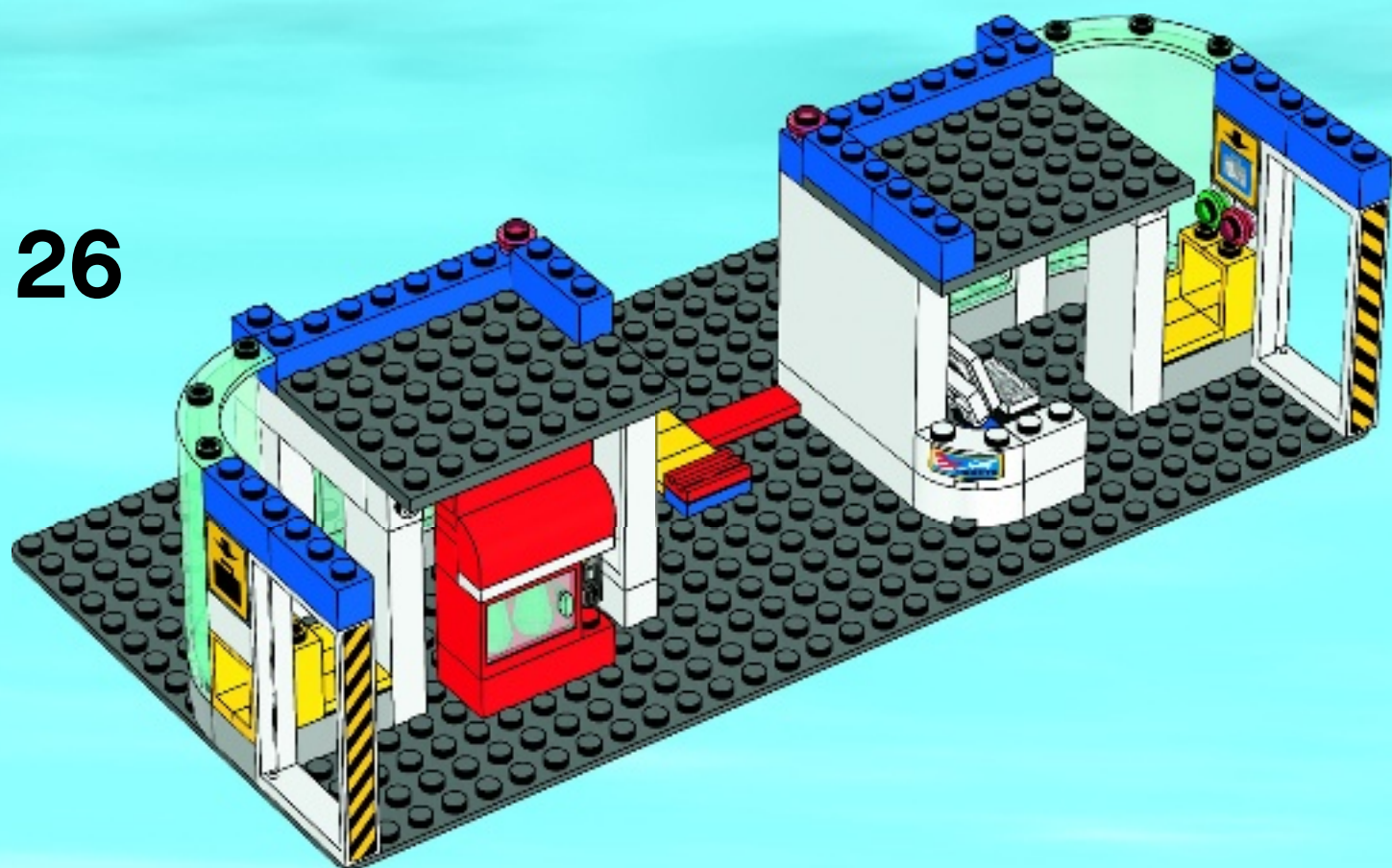

27

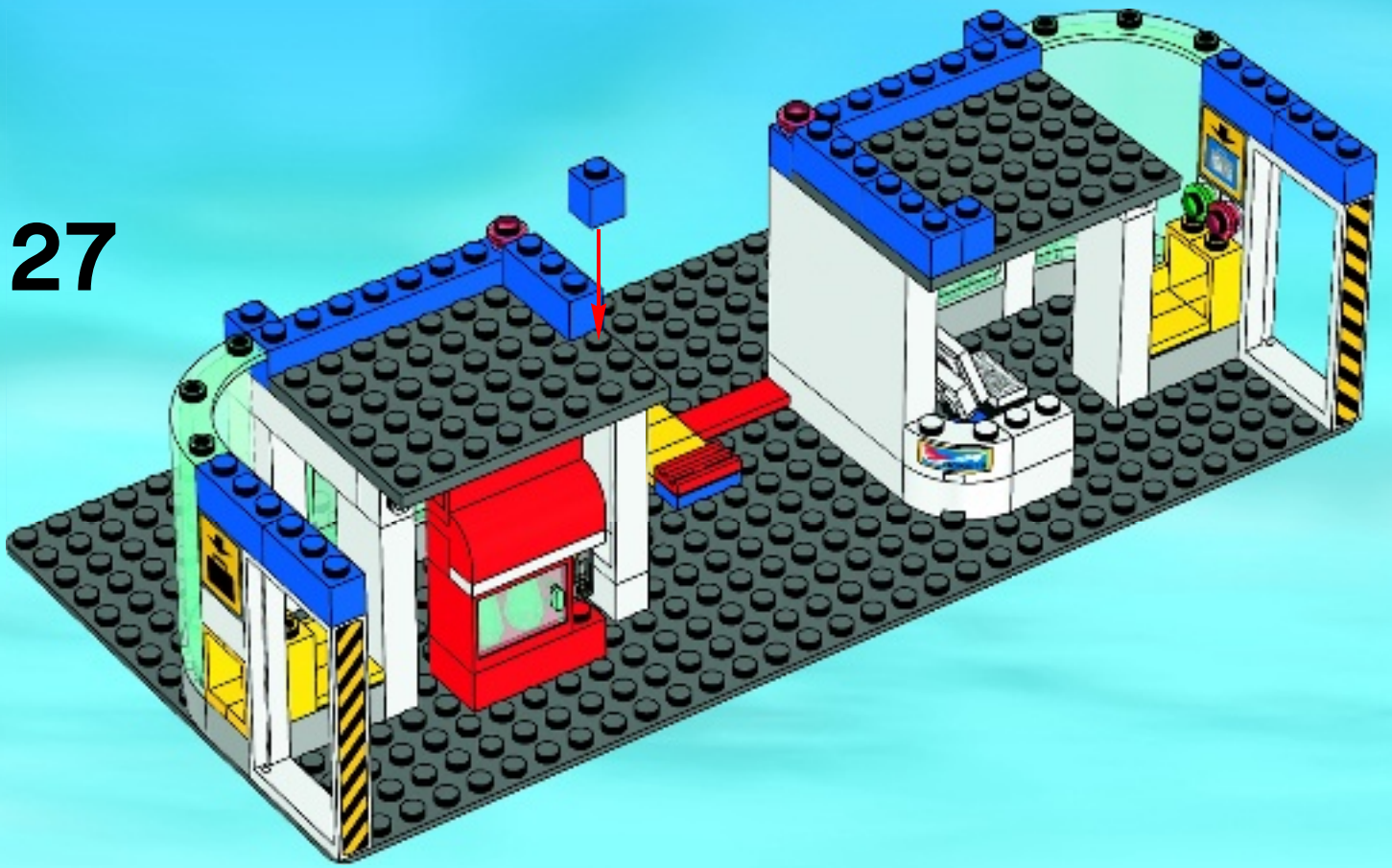

28

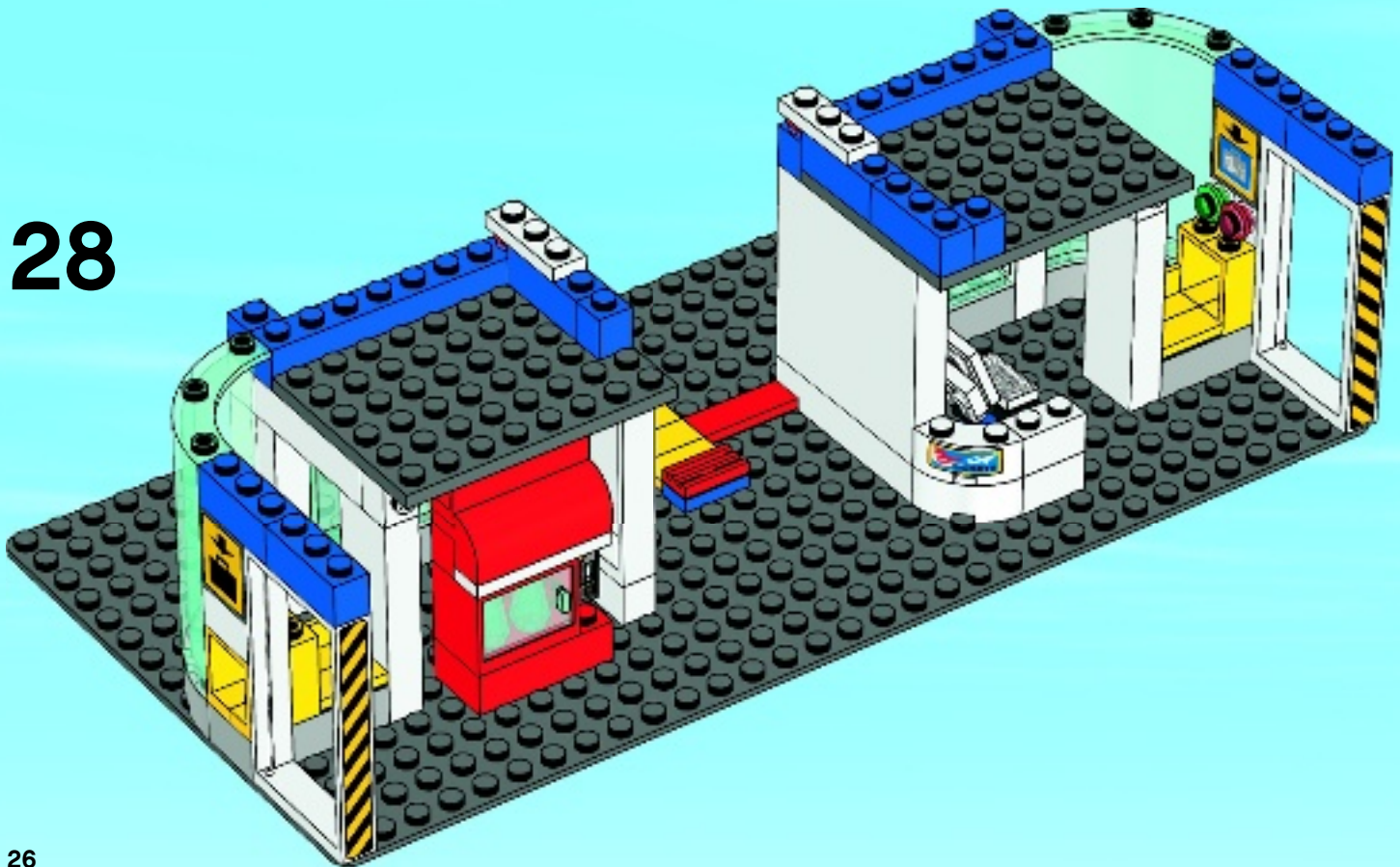

29

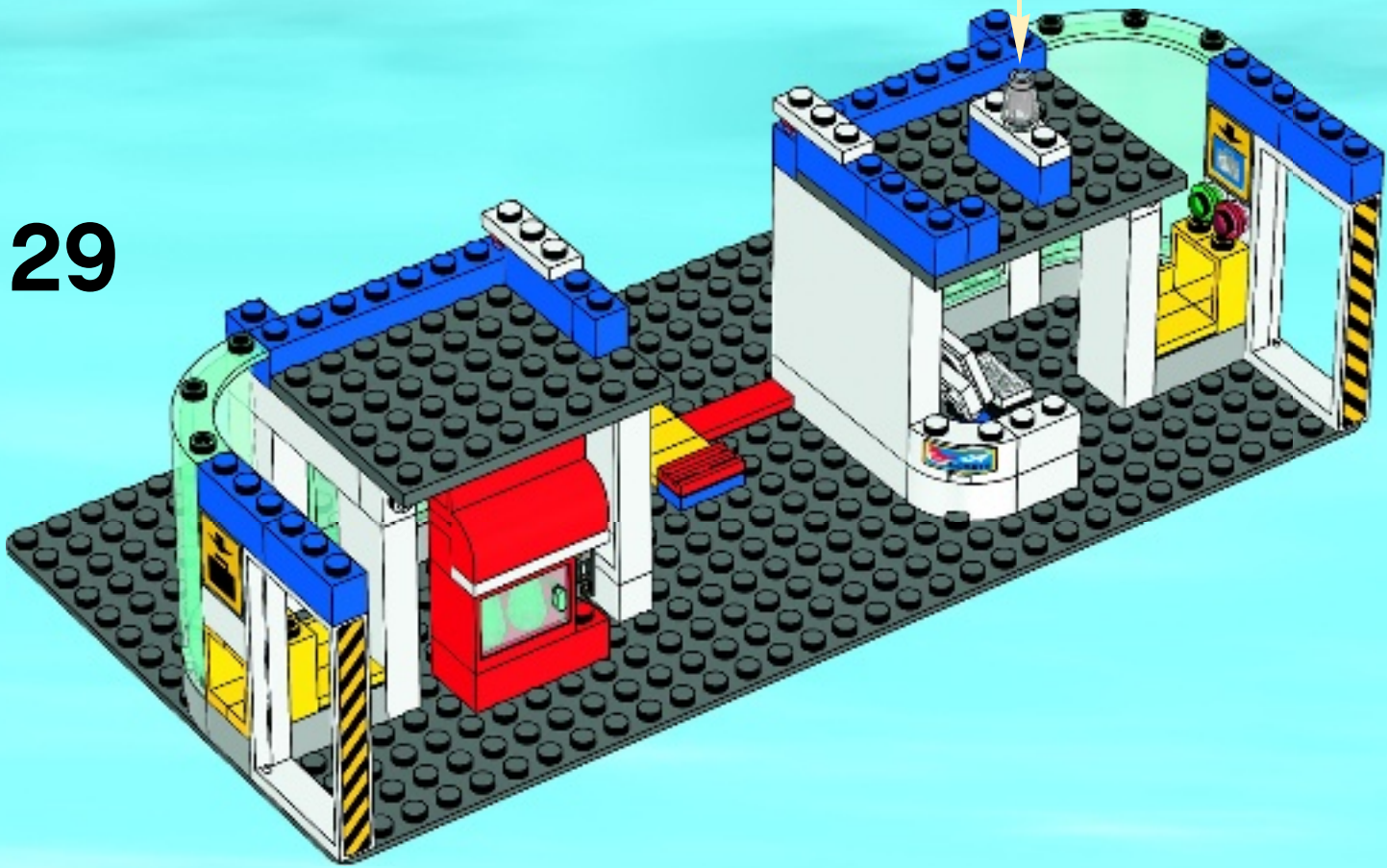
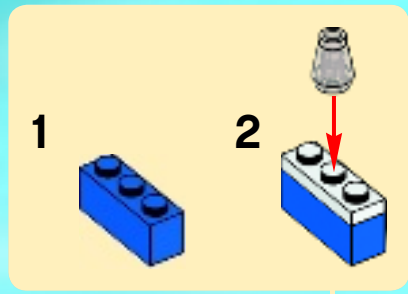



1

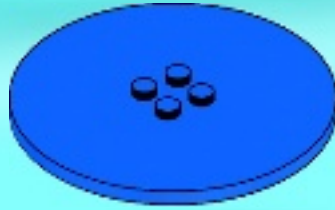

2

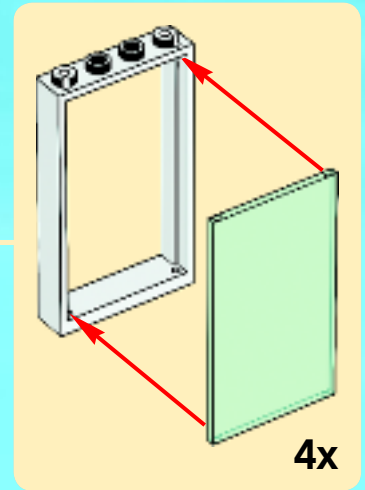
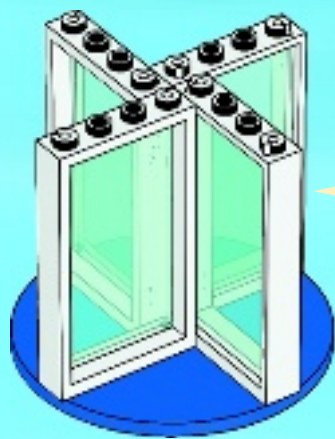

3

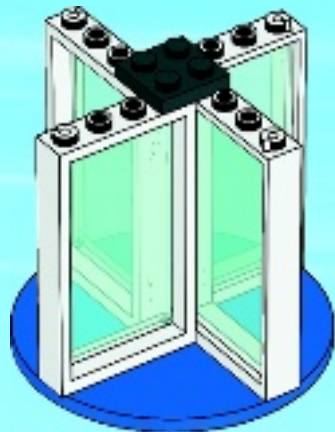

4

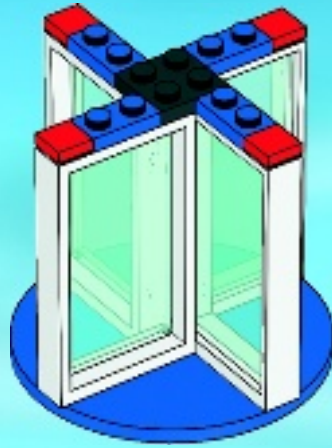

5



6

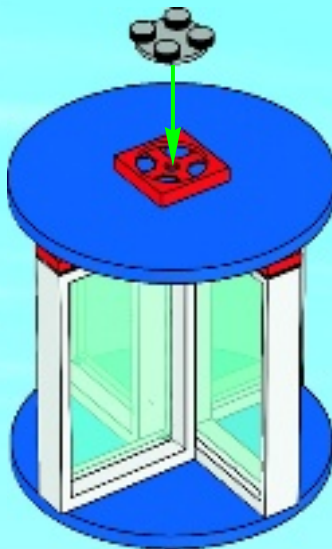

7

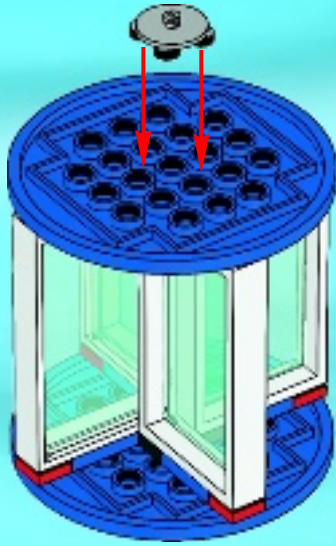

8

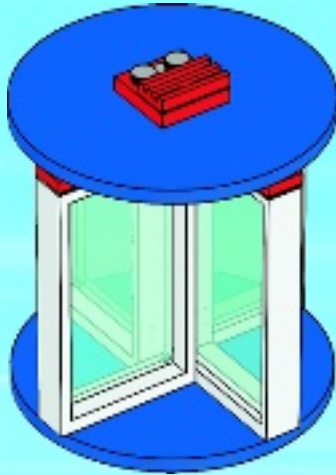

30

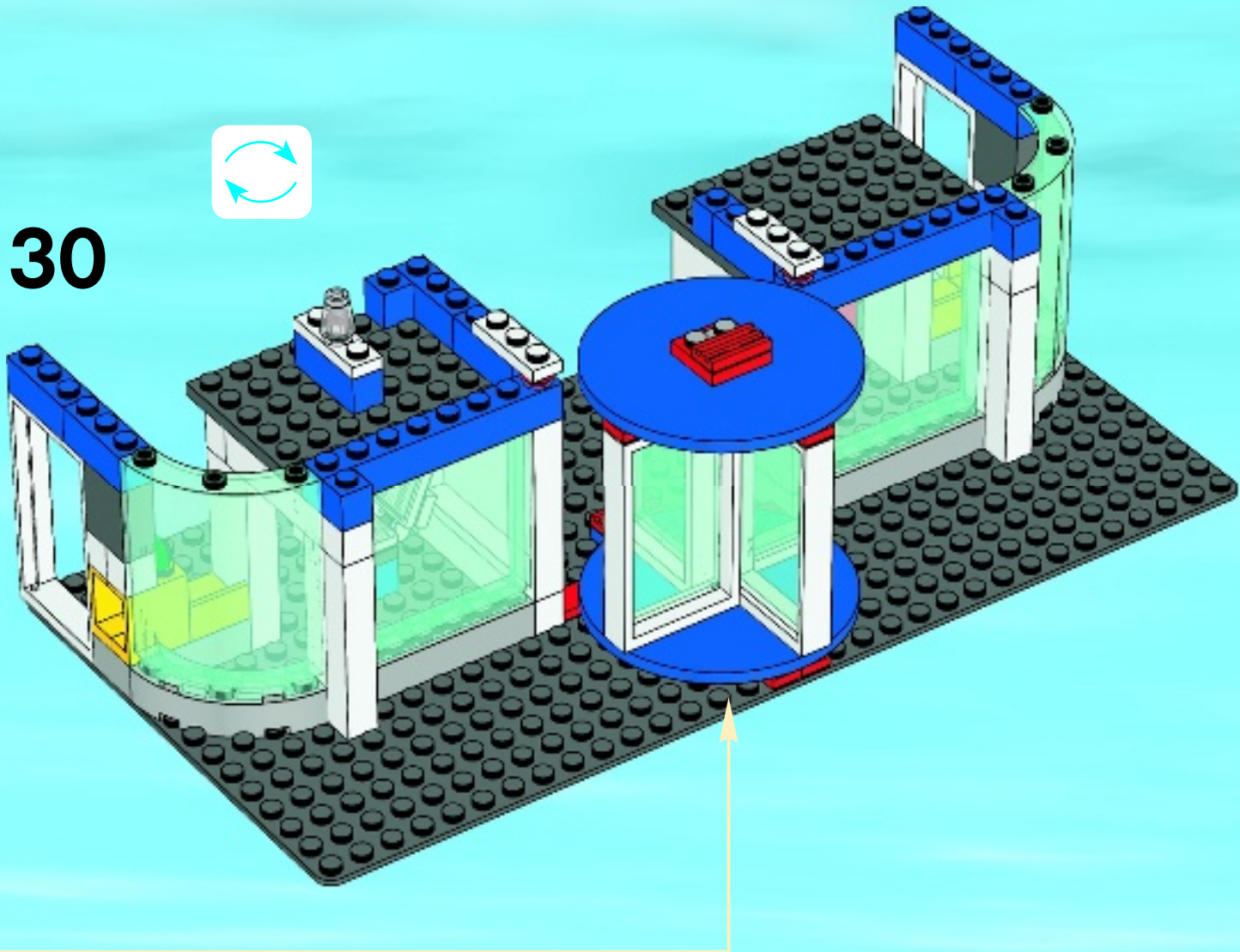

1

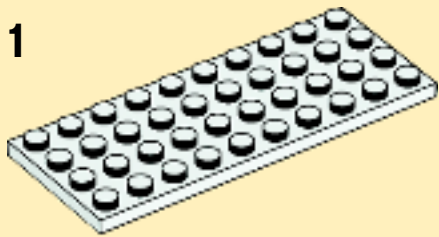

2

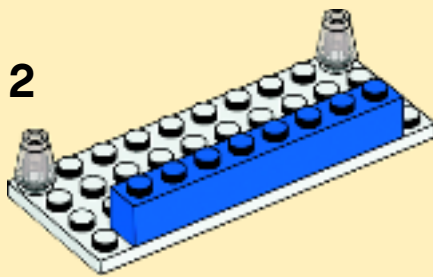

3

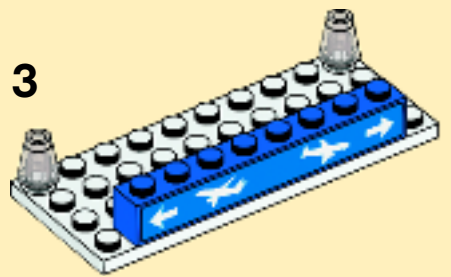

31

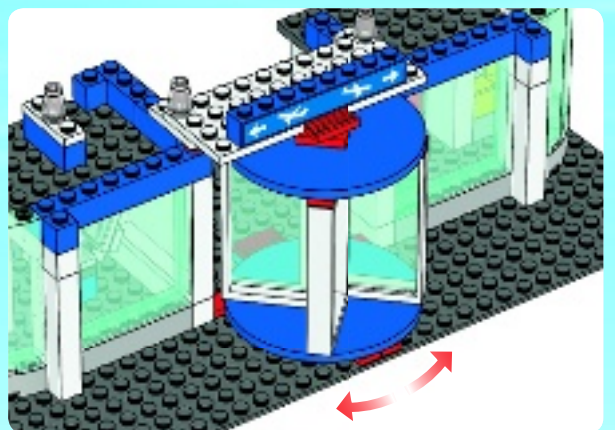
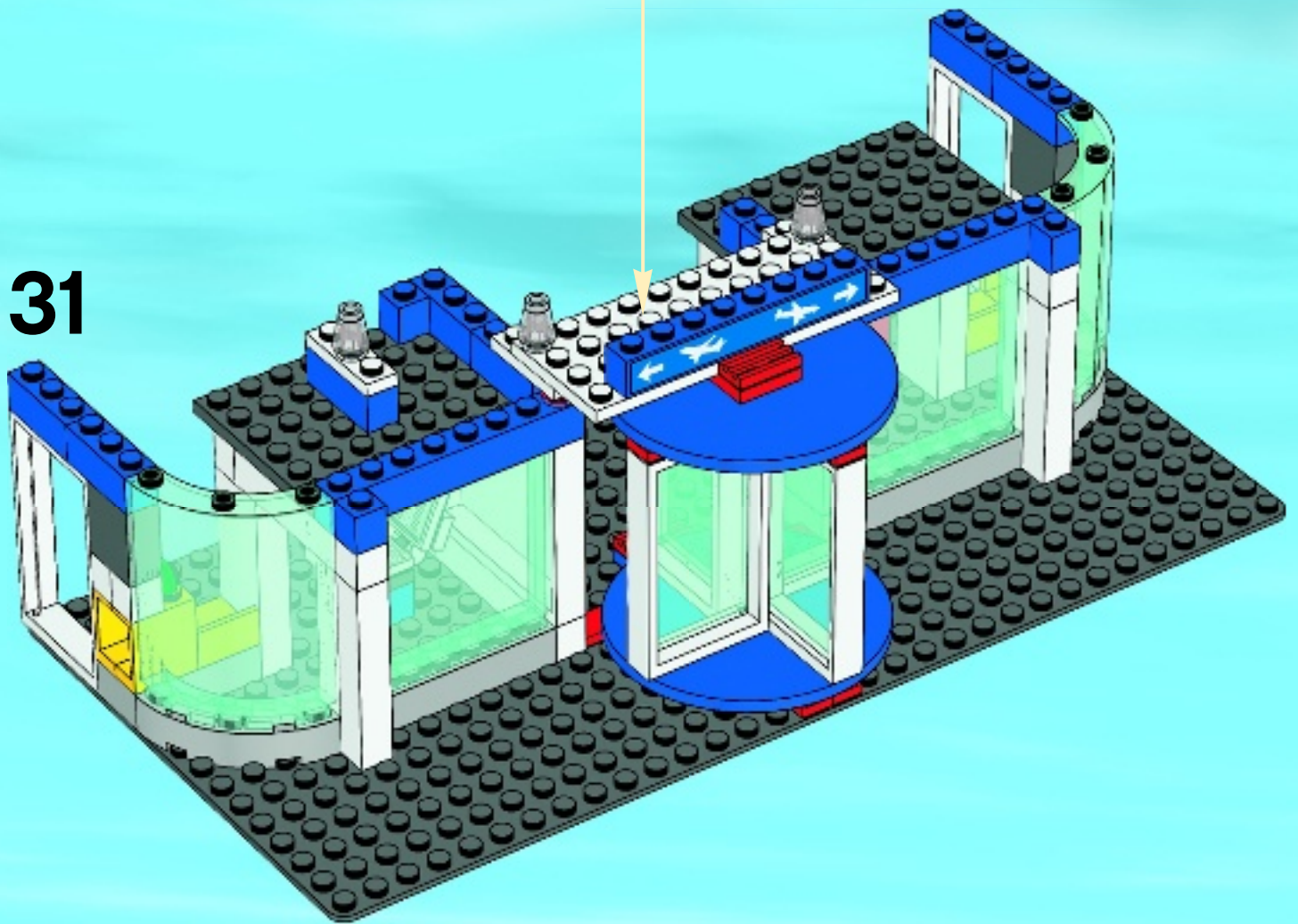



5

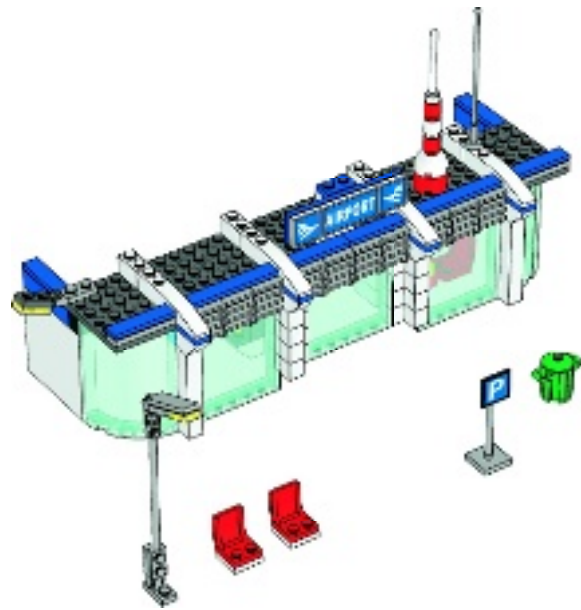

2x



32

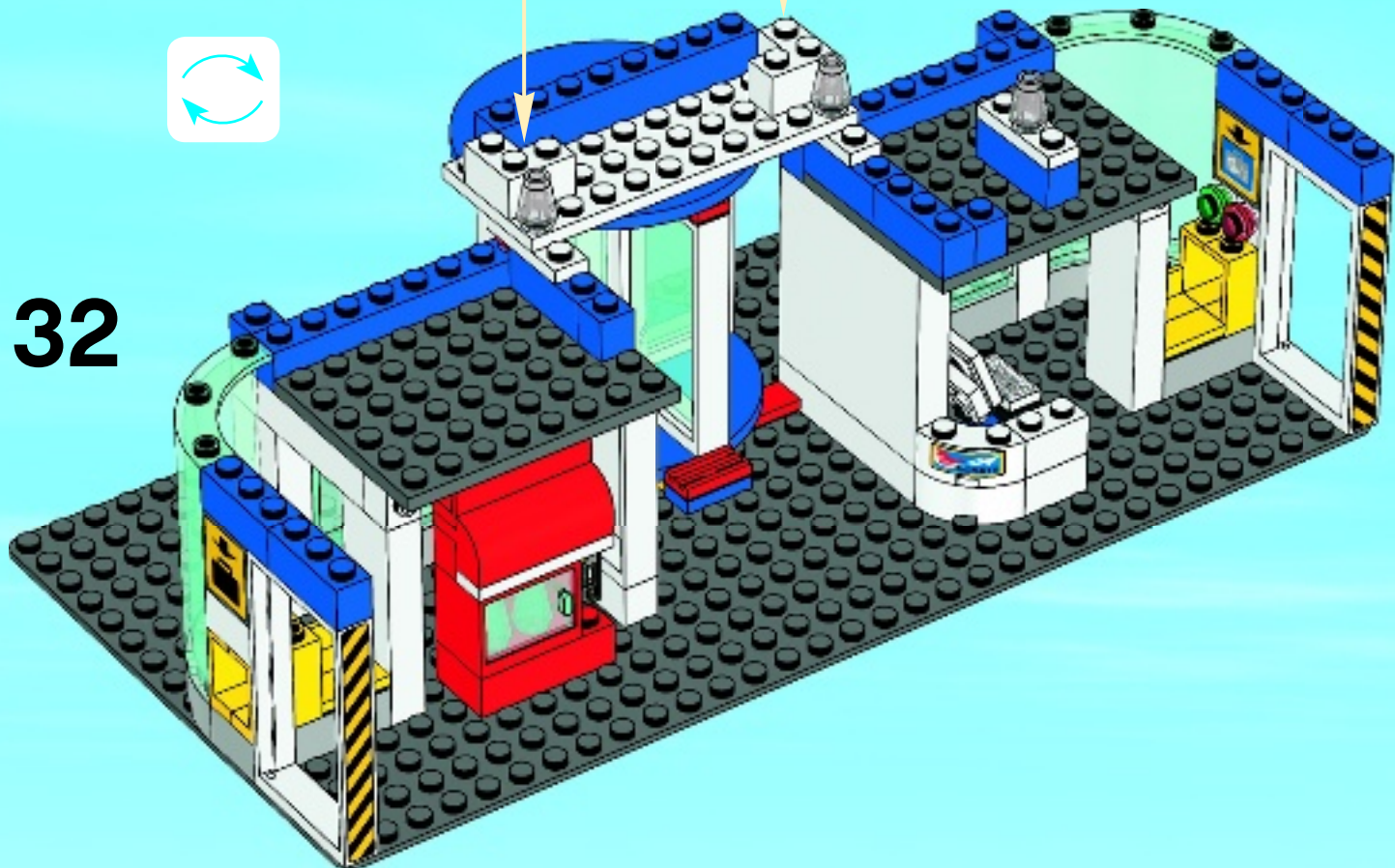

33

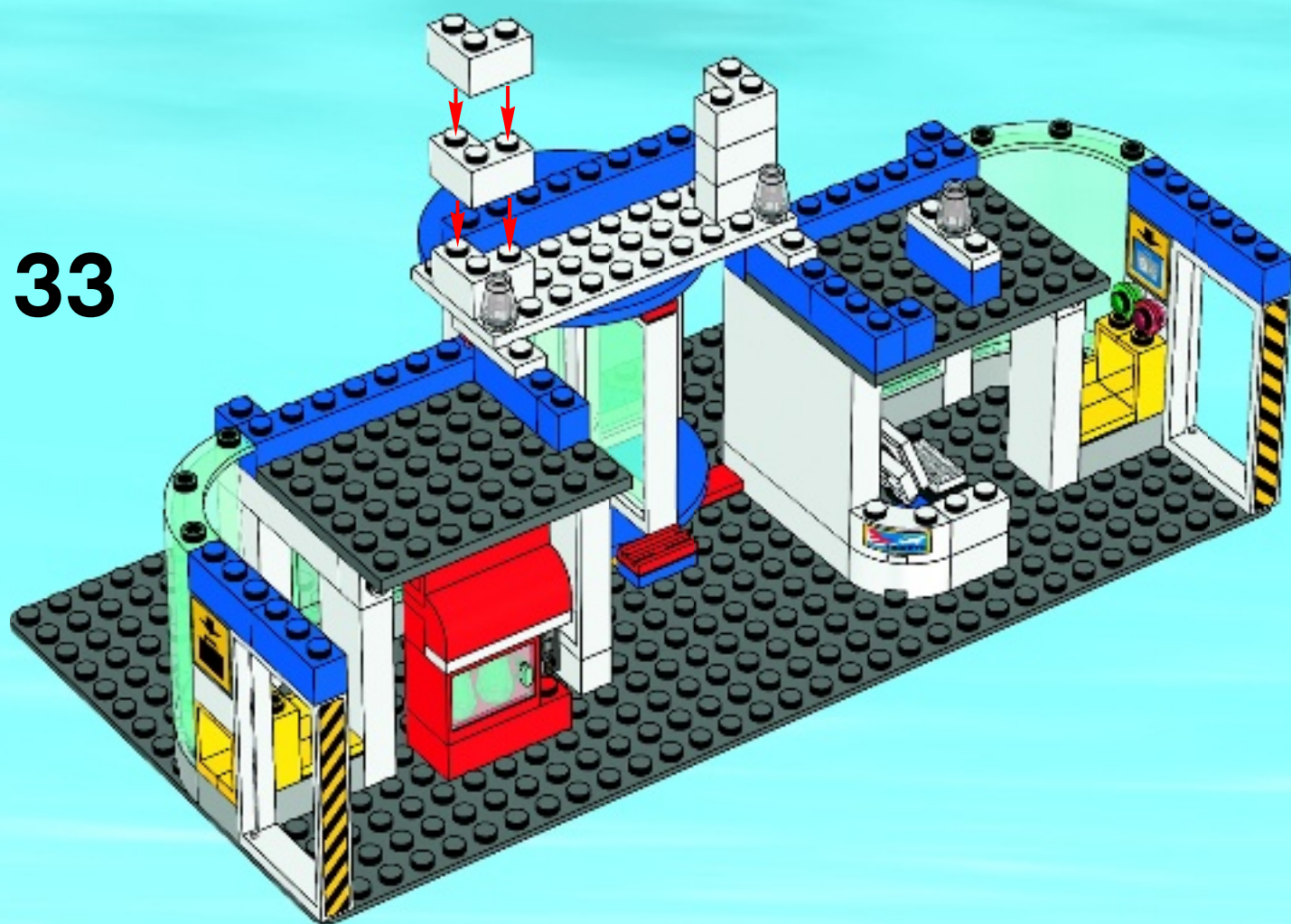

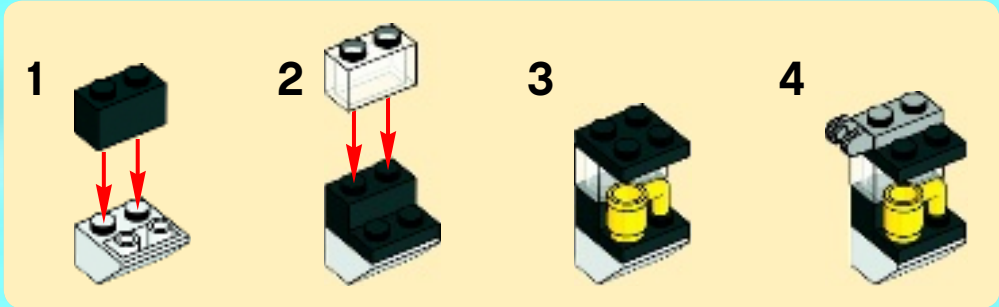

34

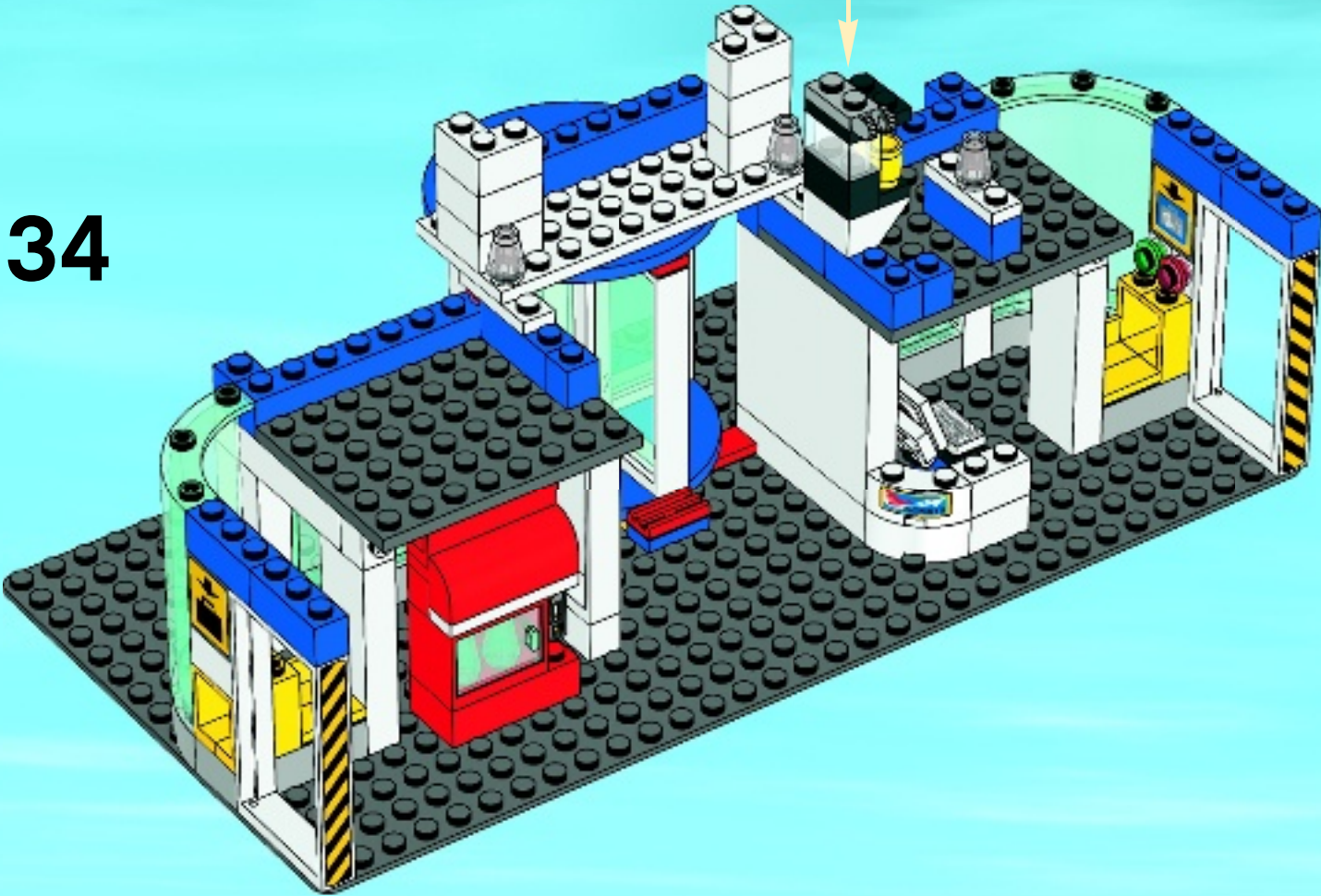

35

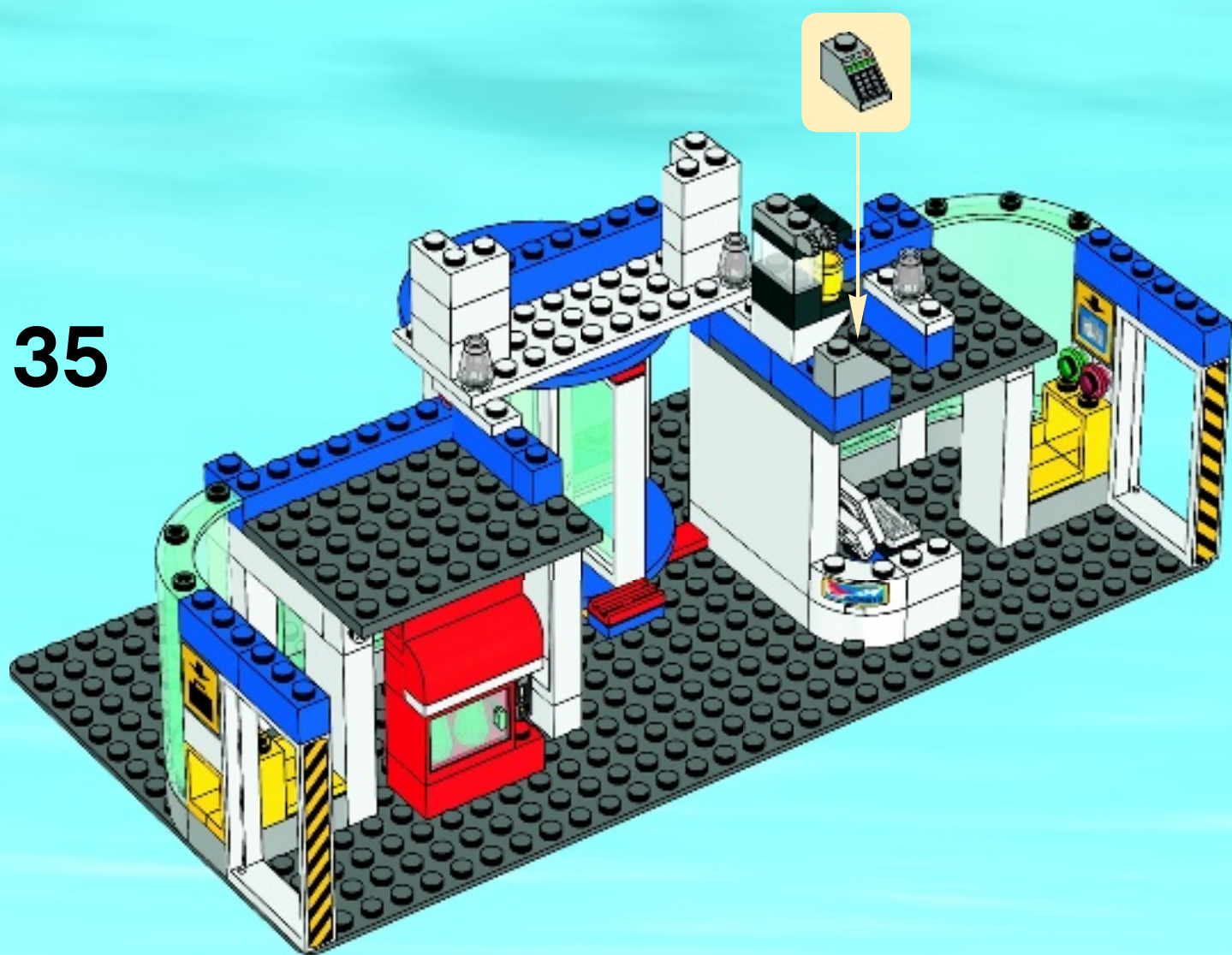

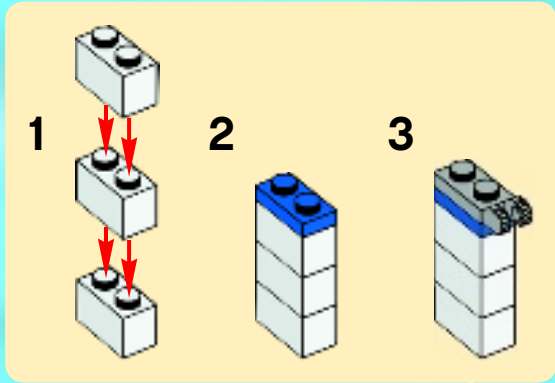

36

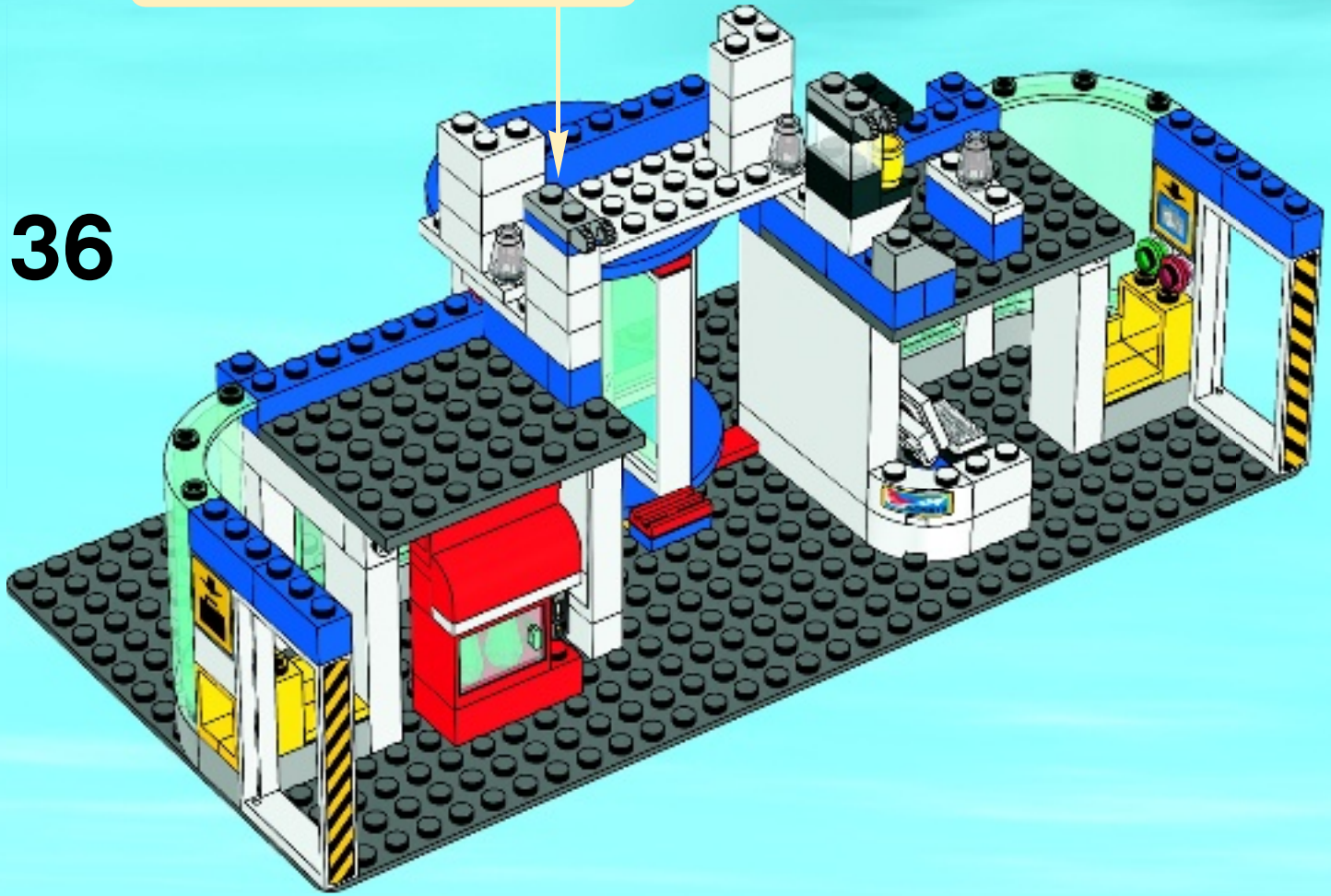

37

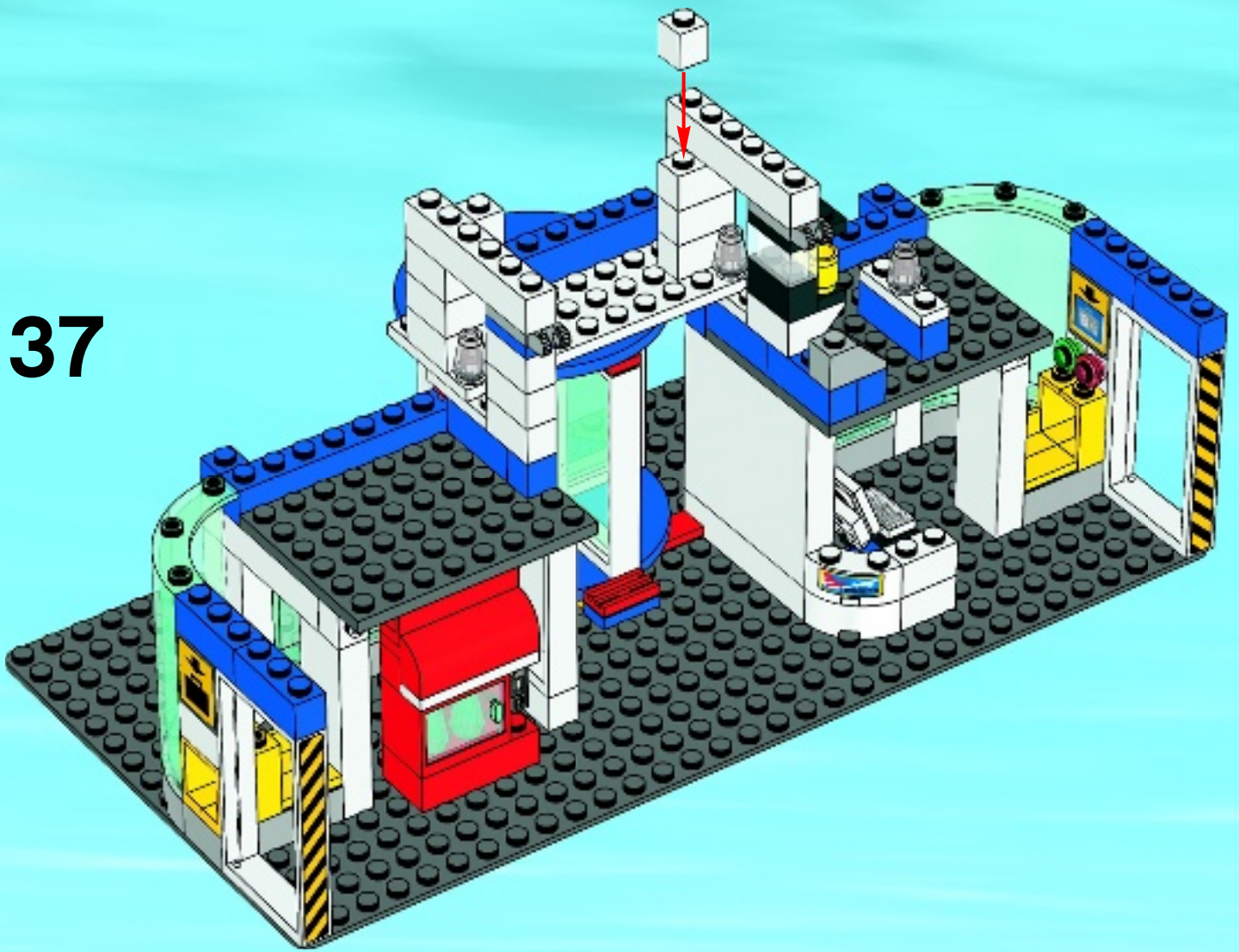

38

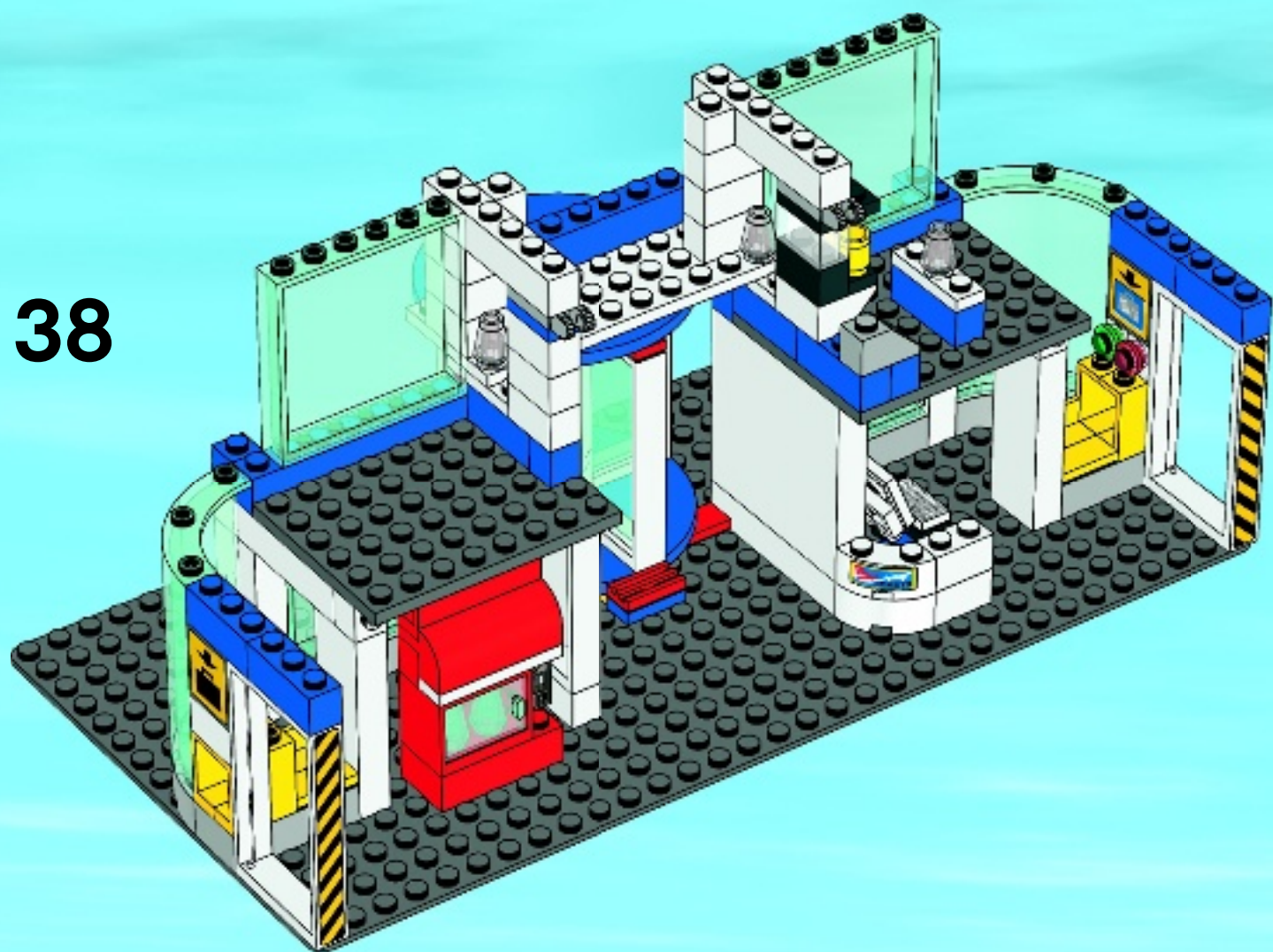

39

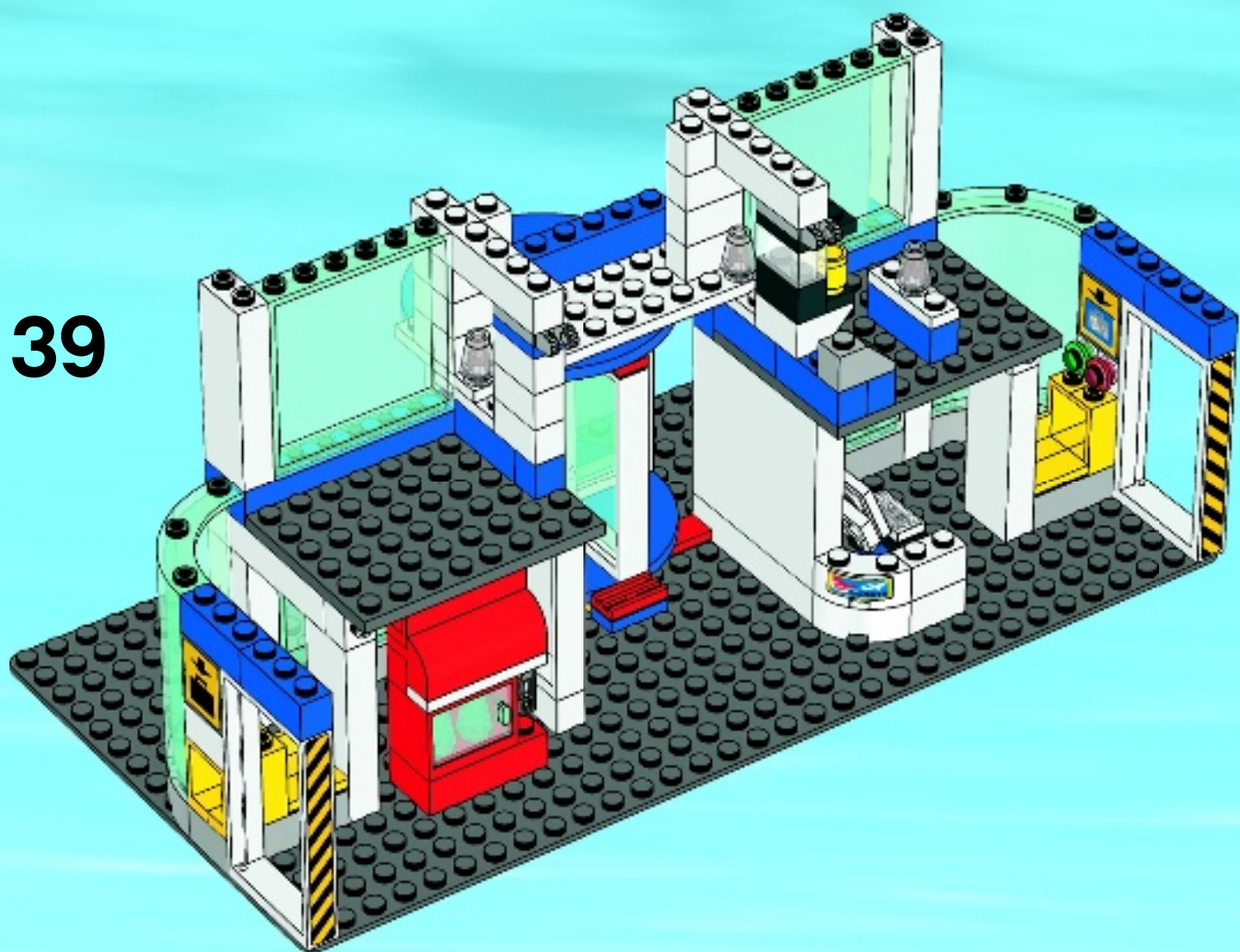

40

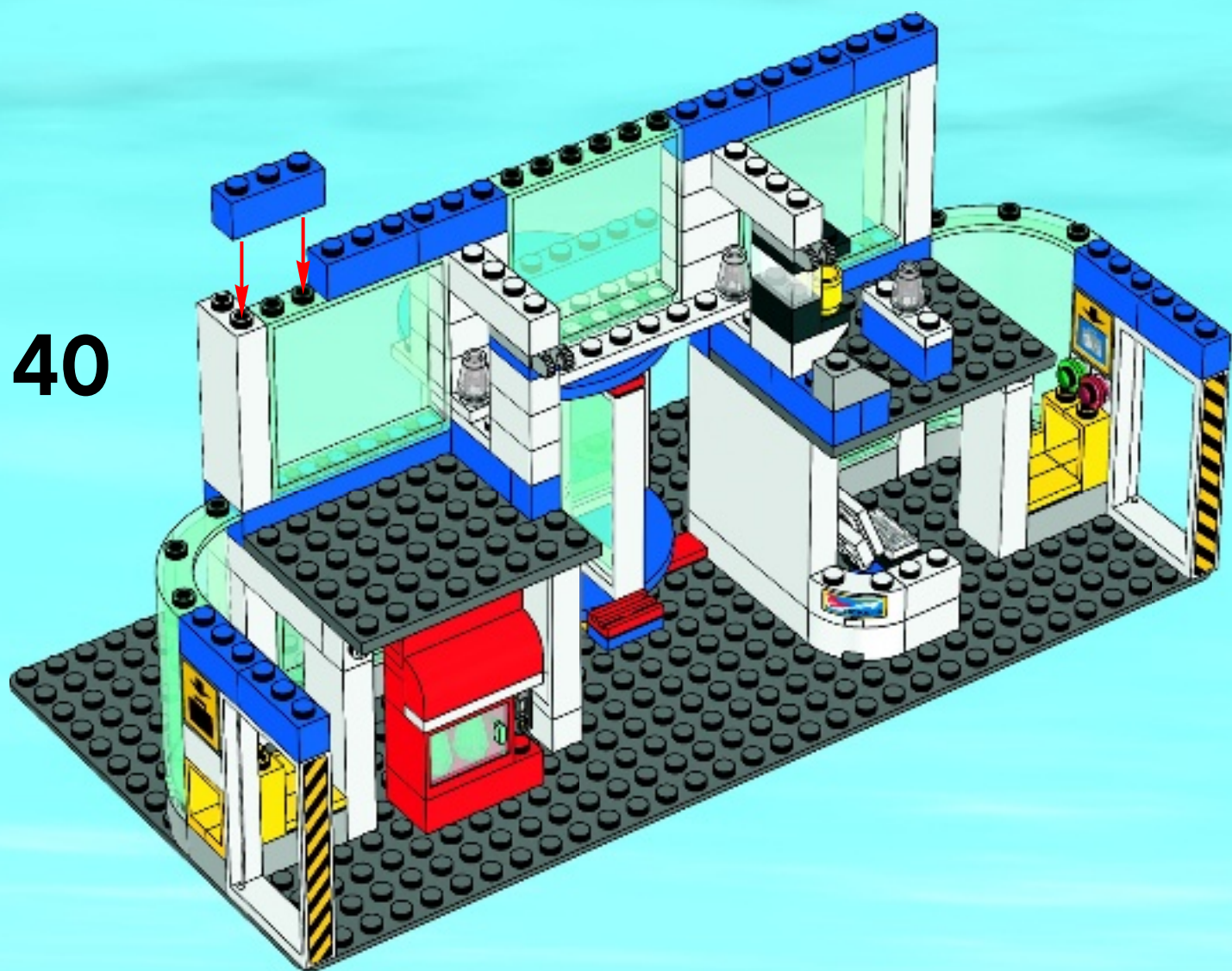

41

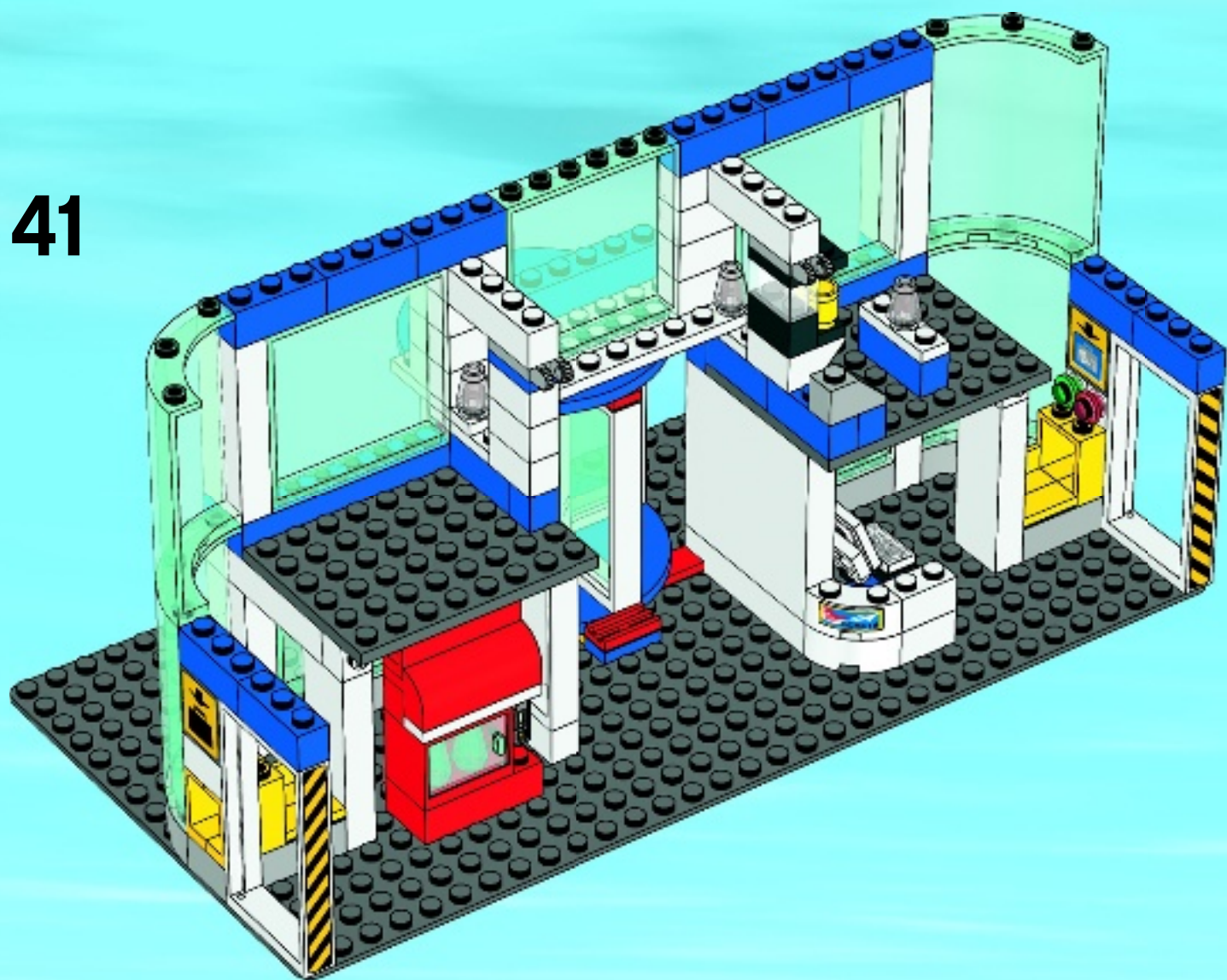

42

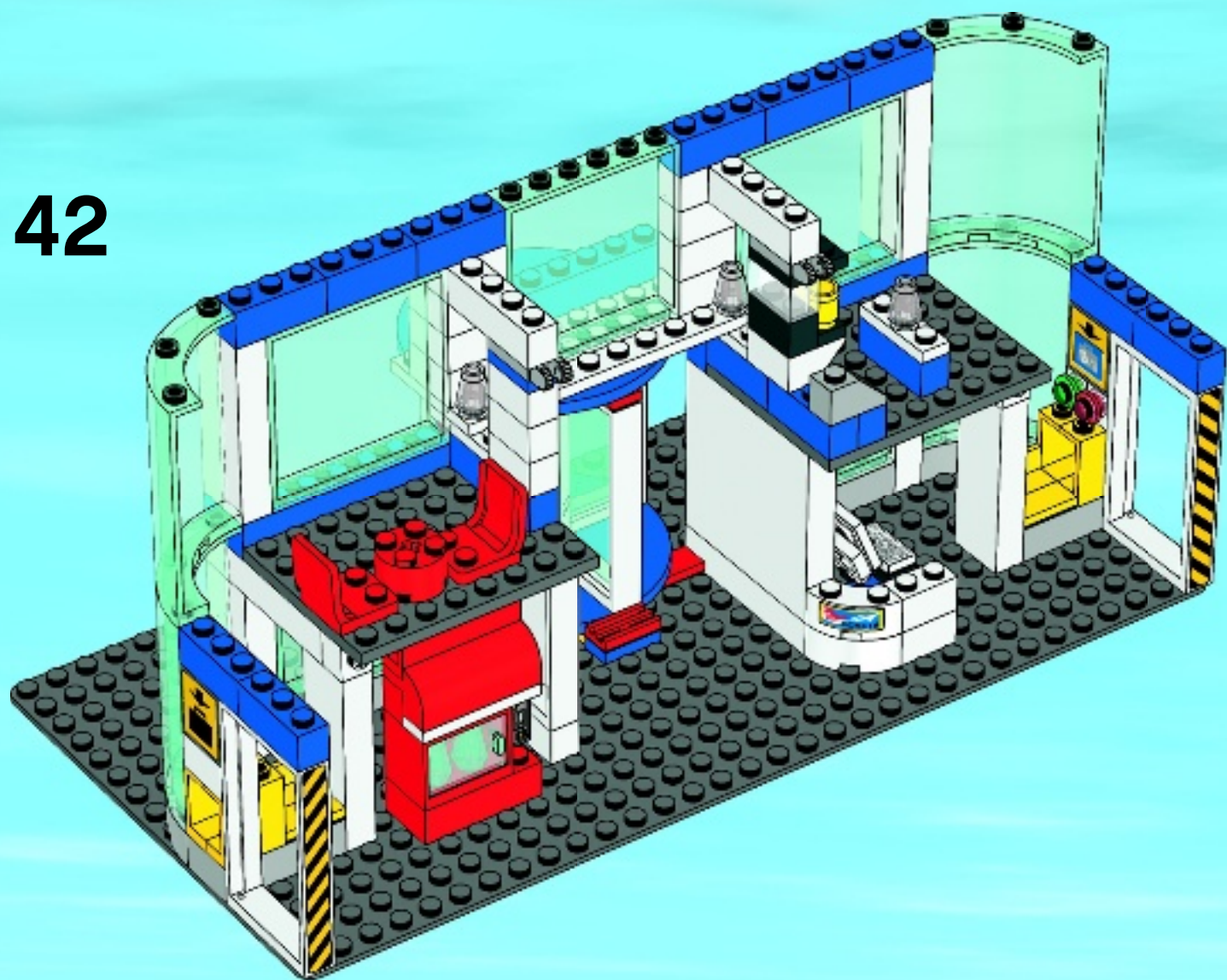

43

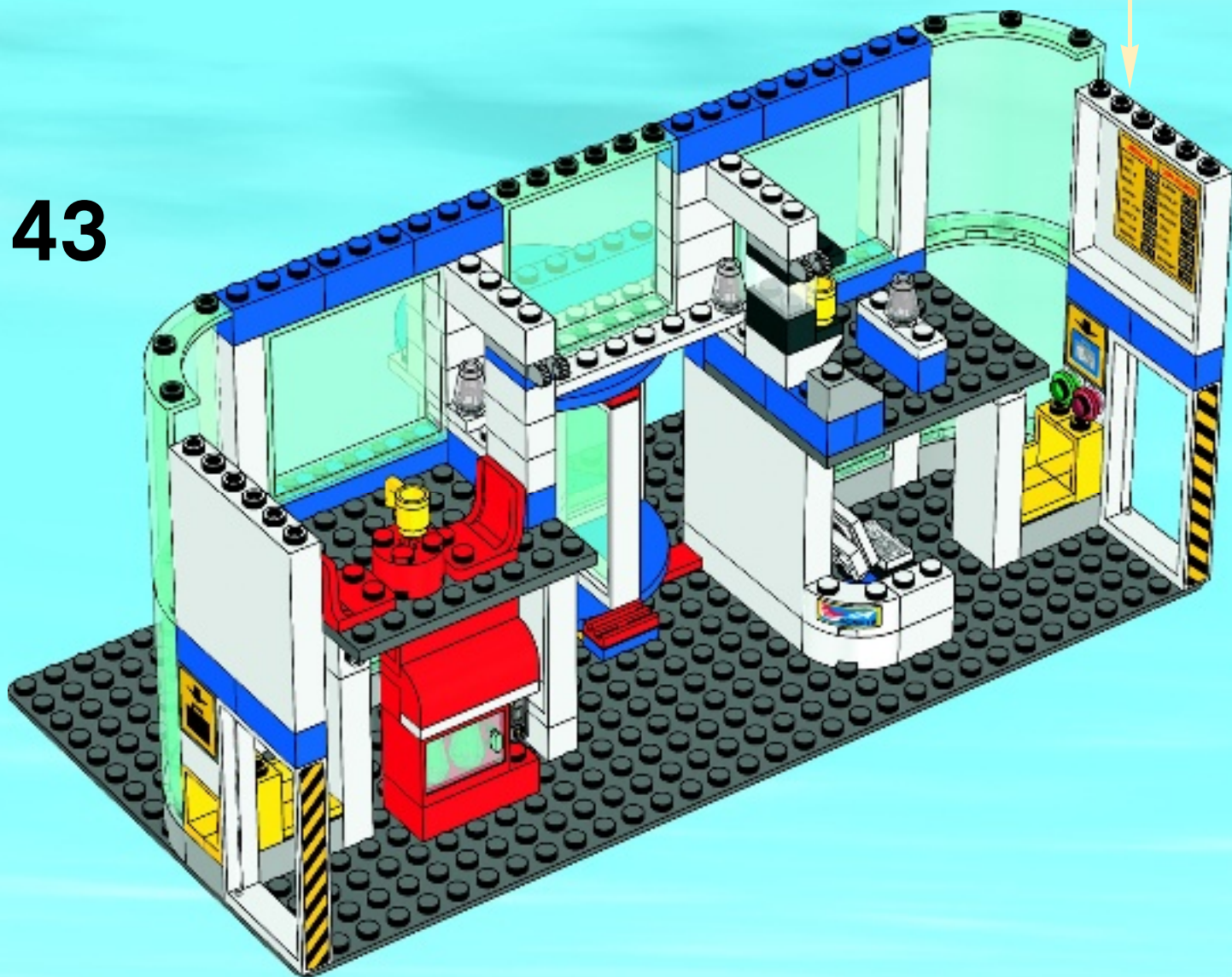
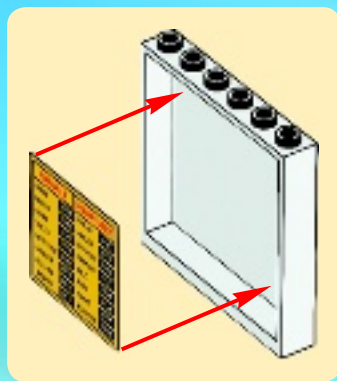

44

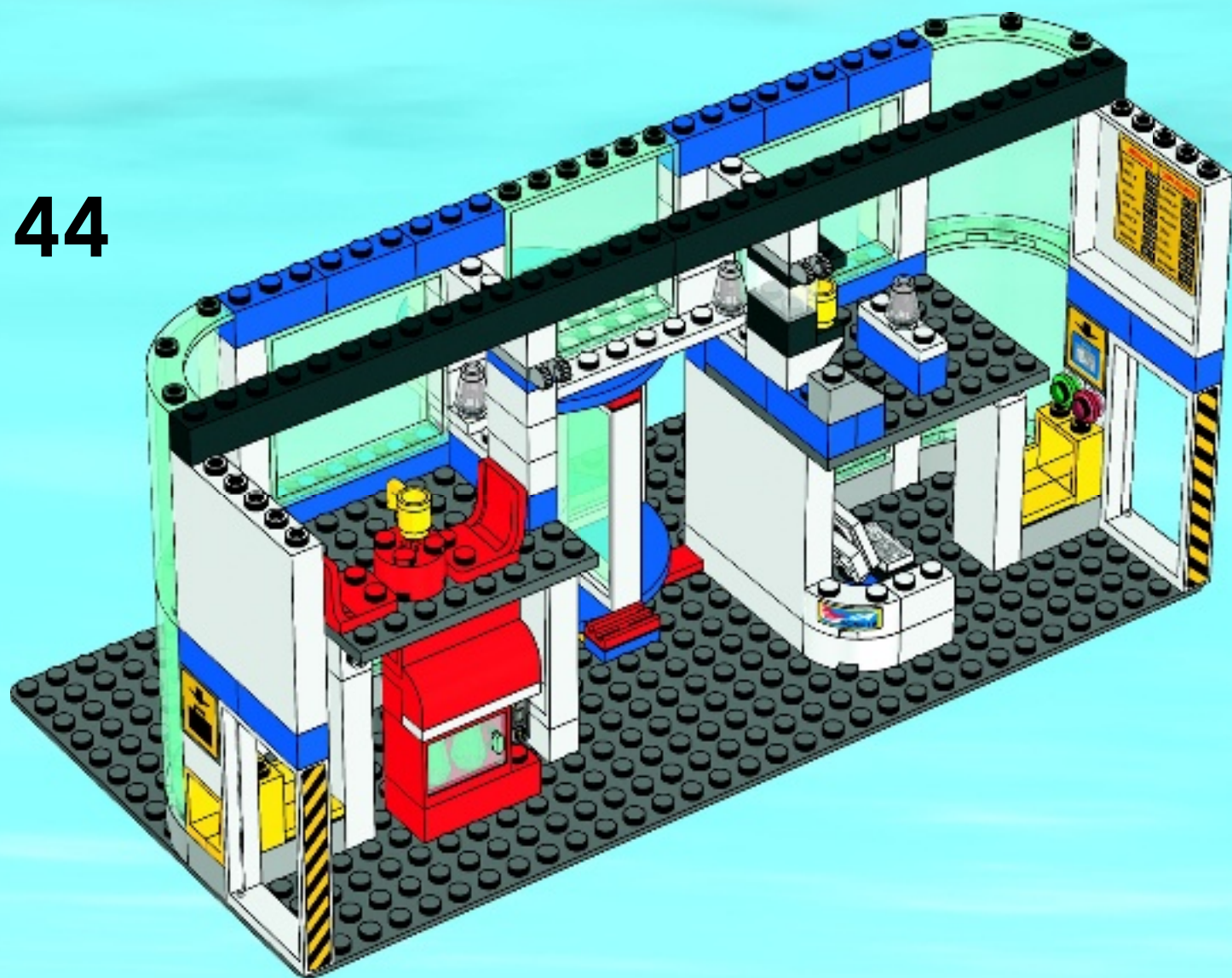

45

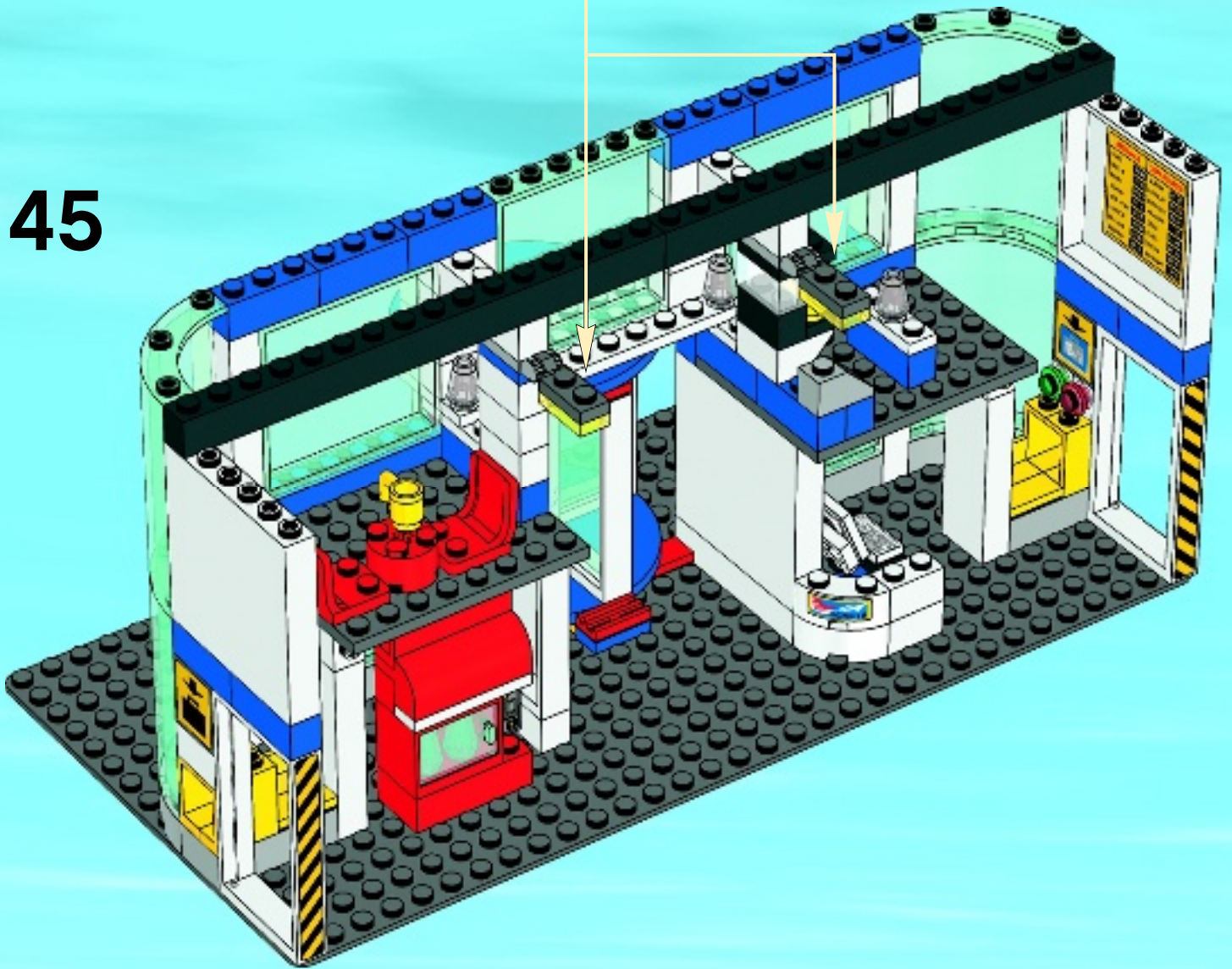
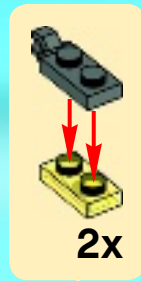

46

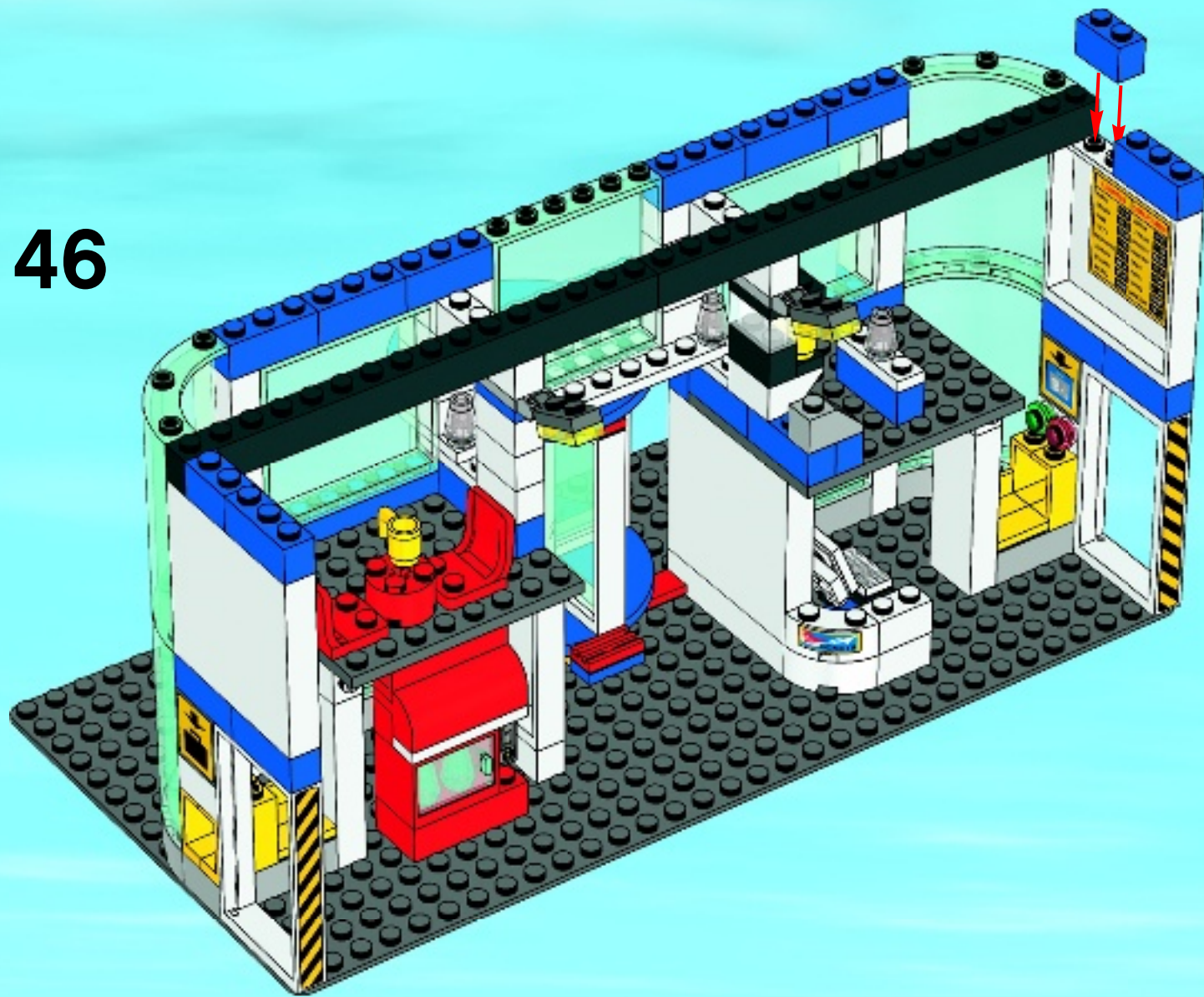



47

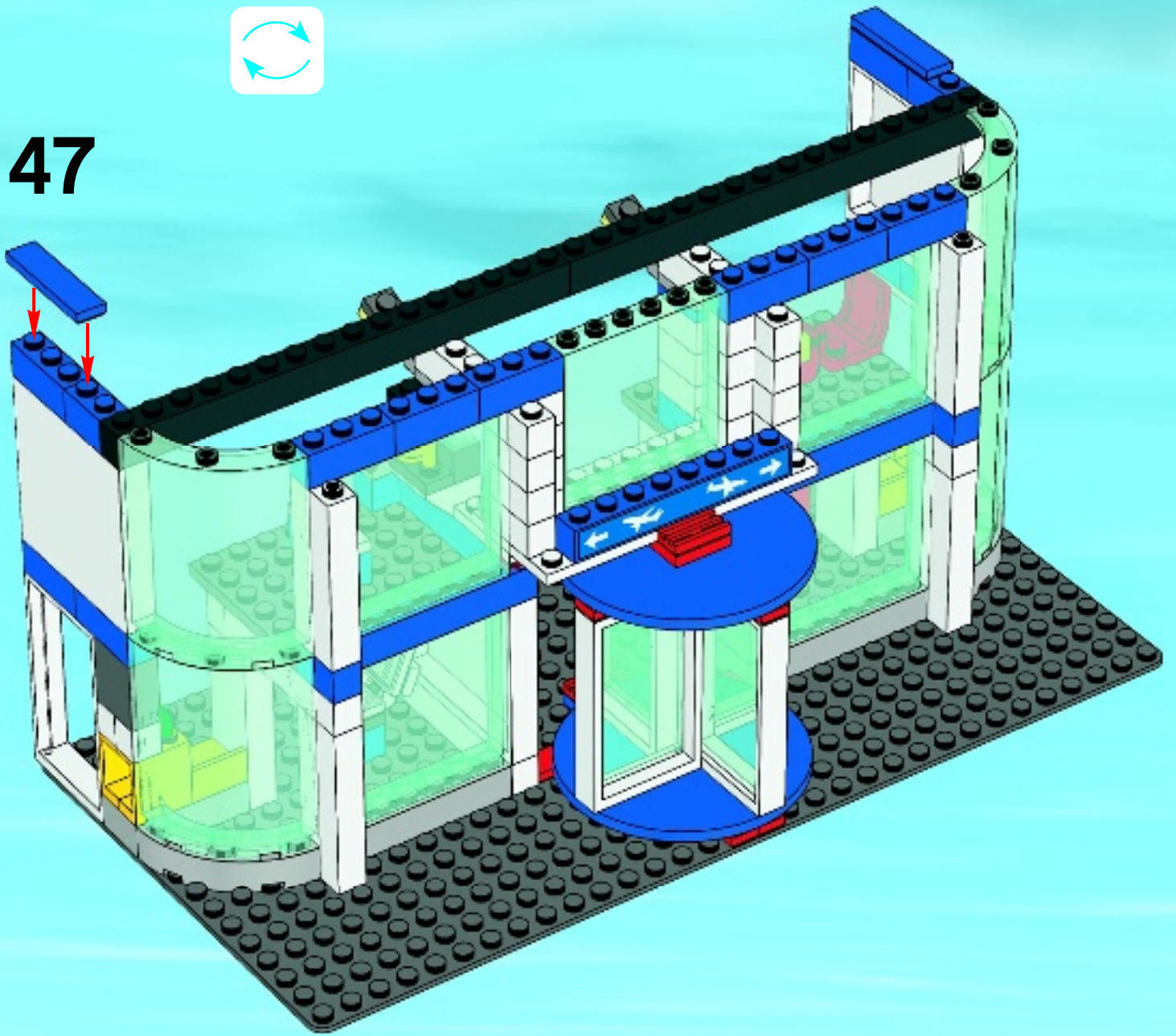

48

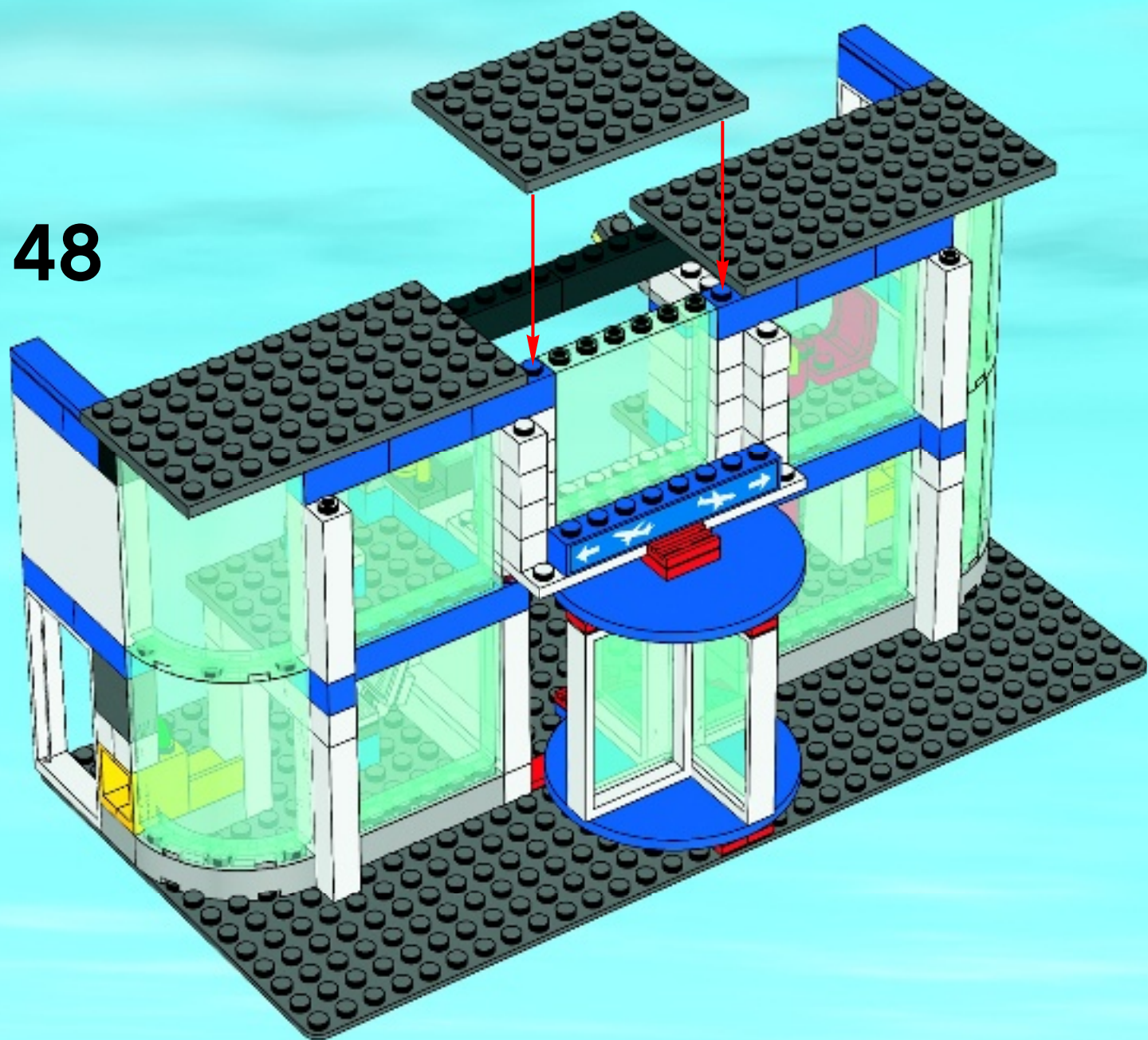

49

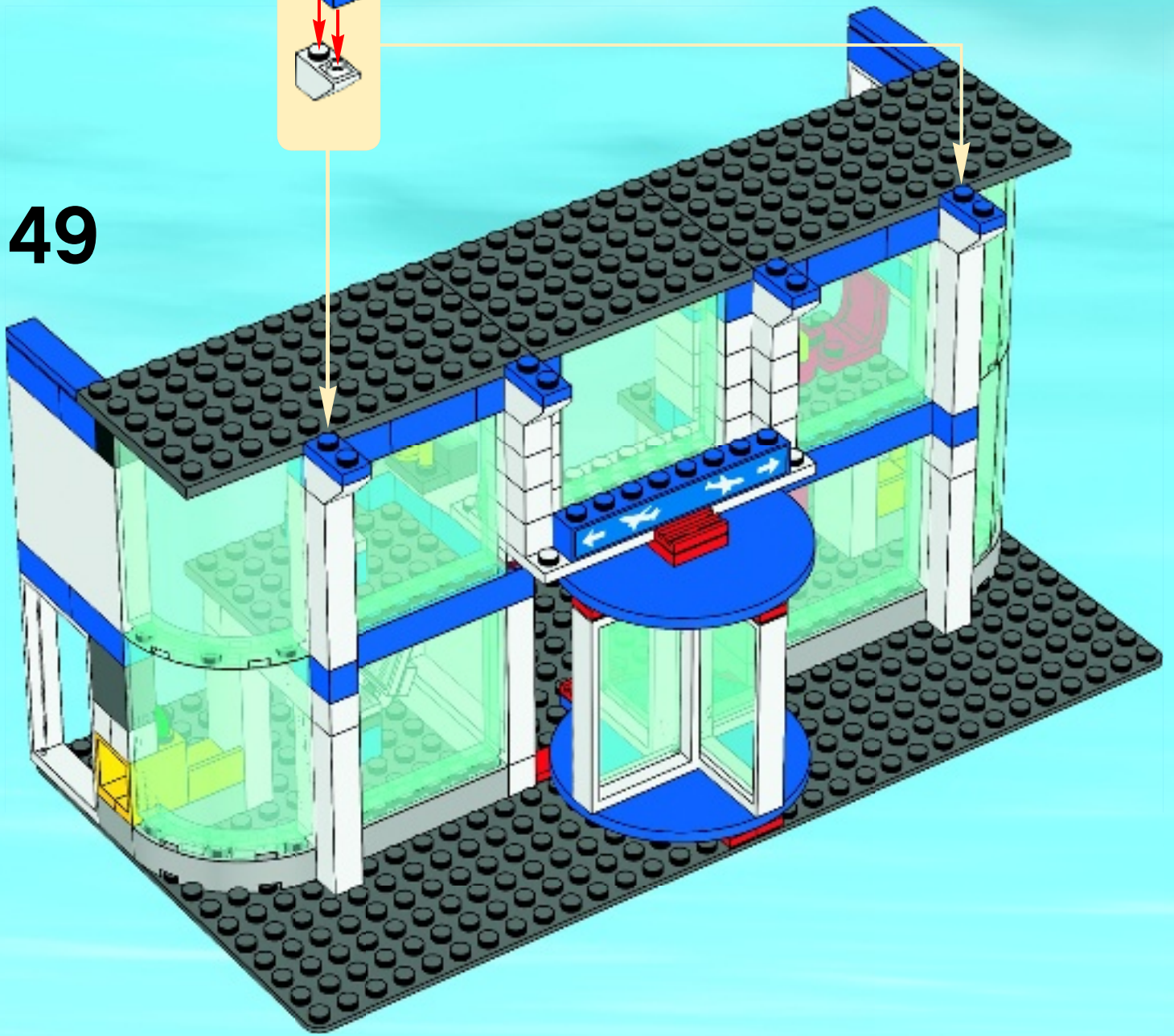
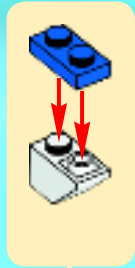

50

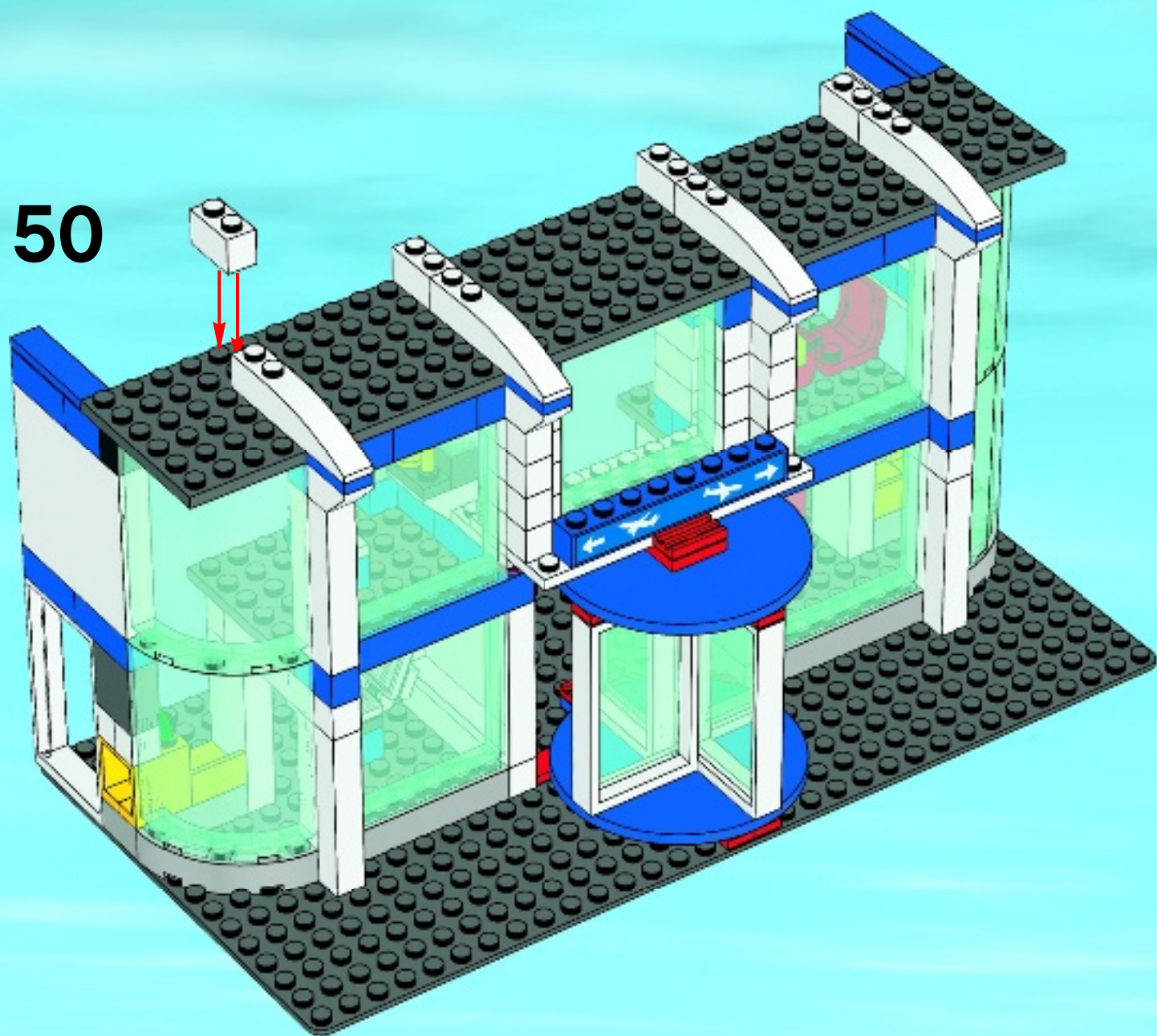

51

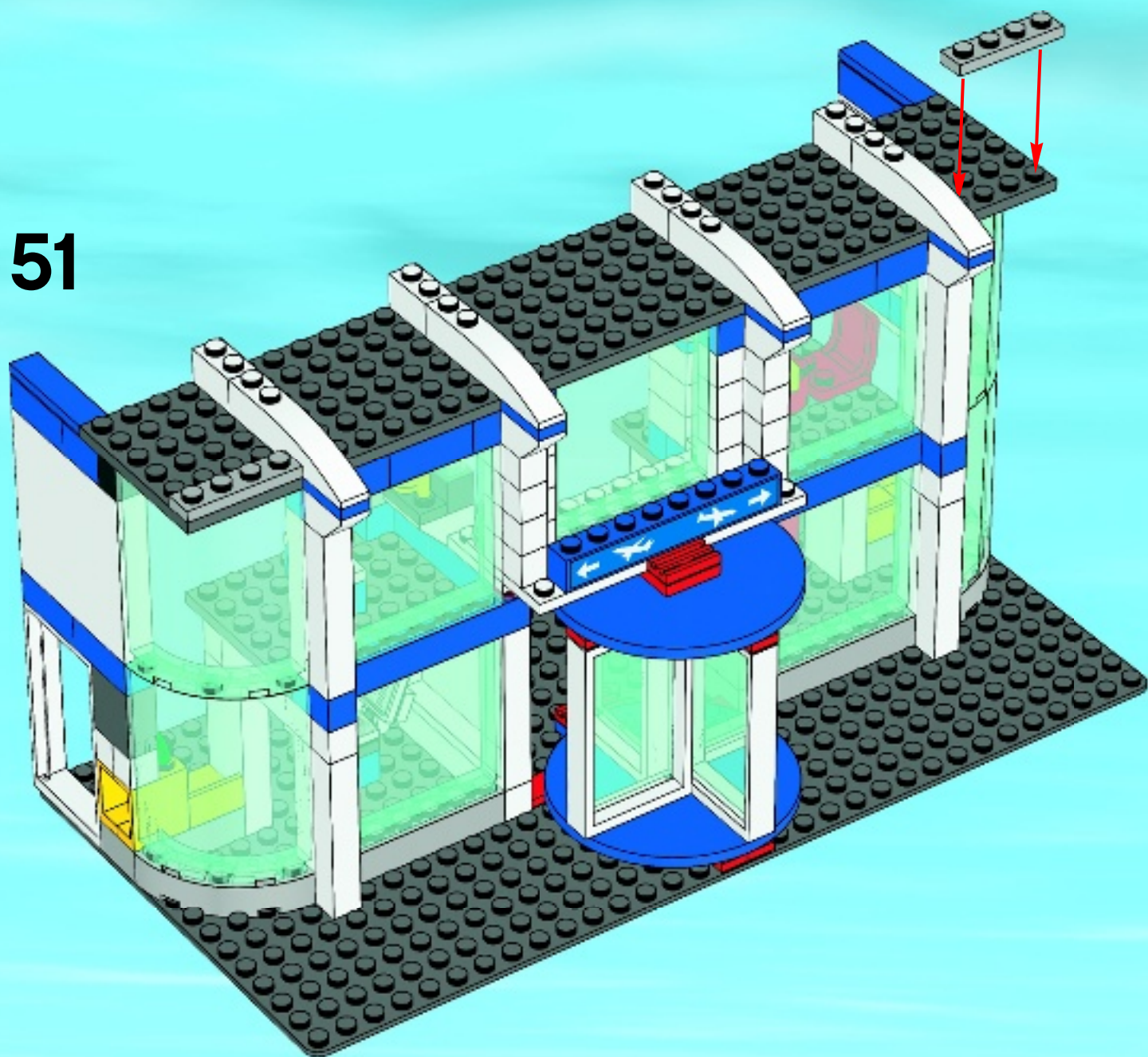

52

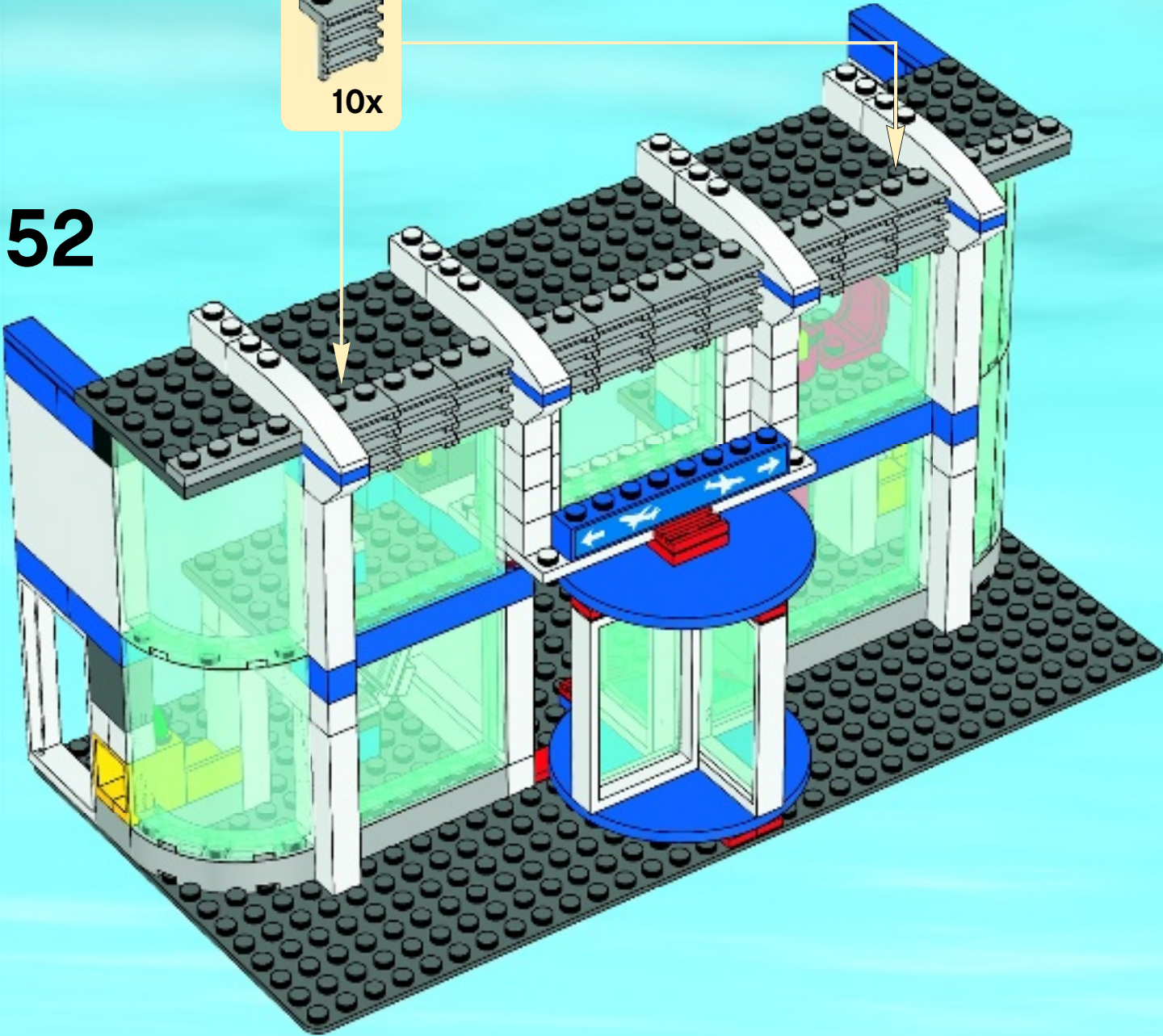
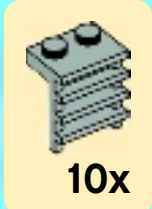

53

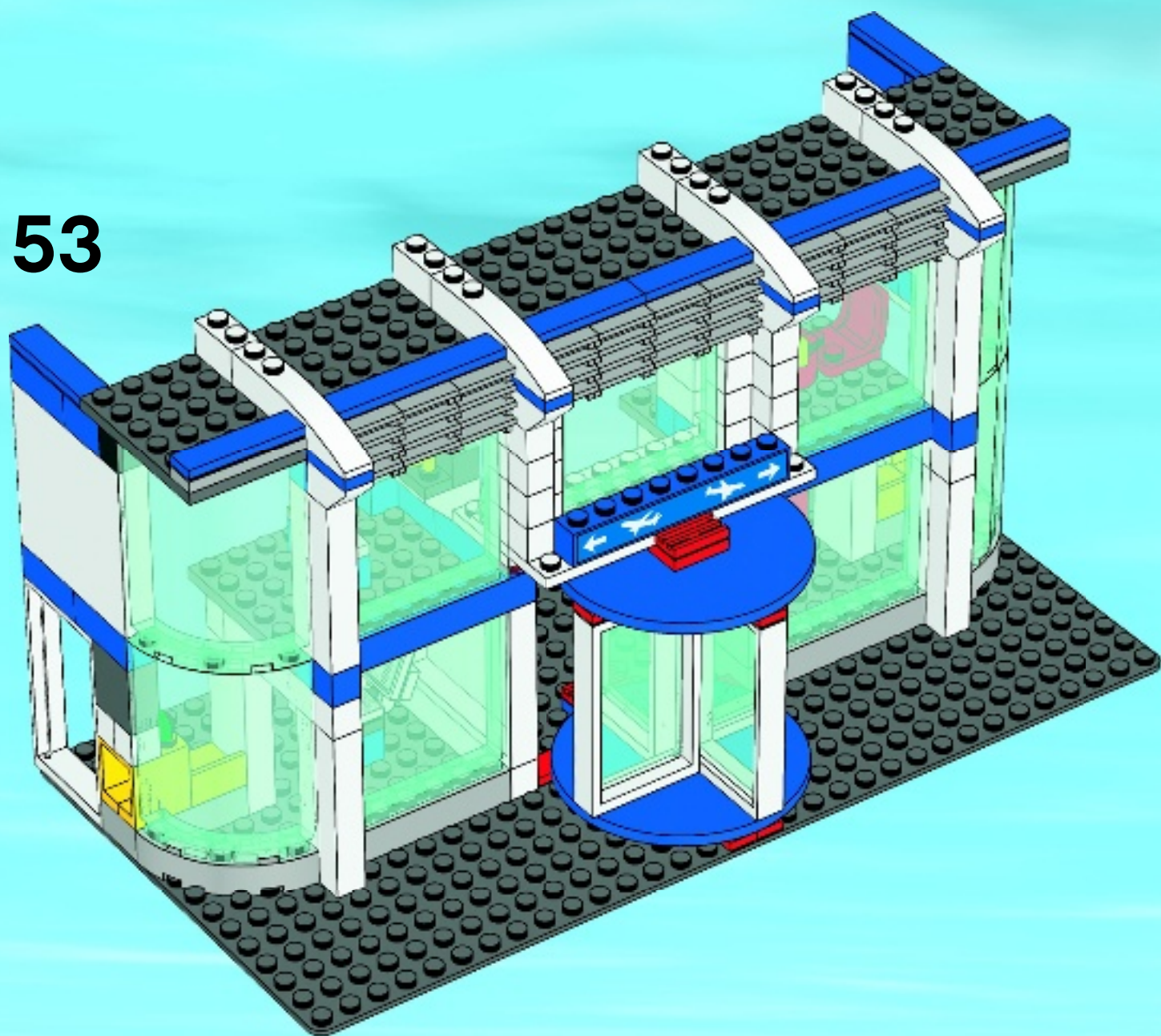

54

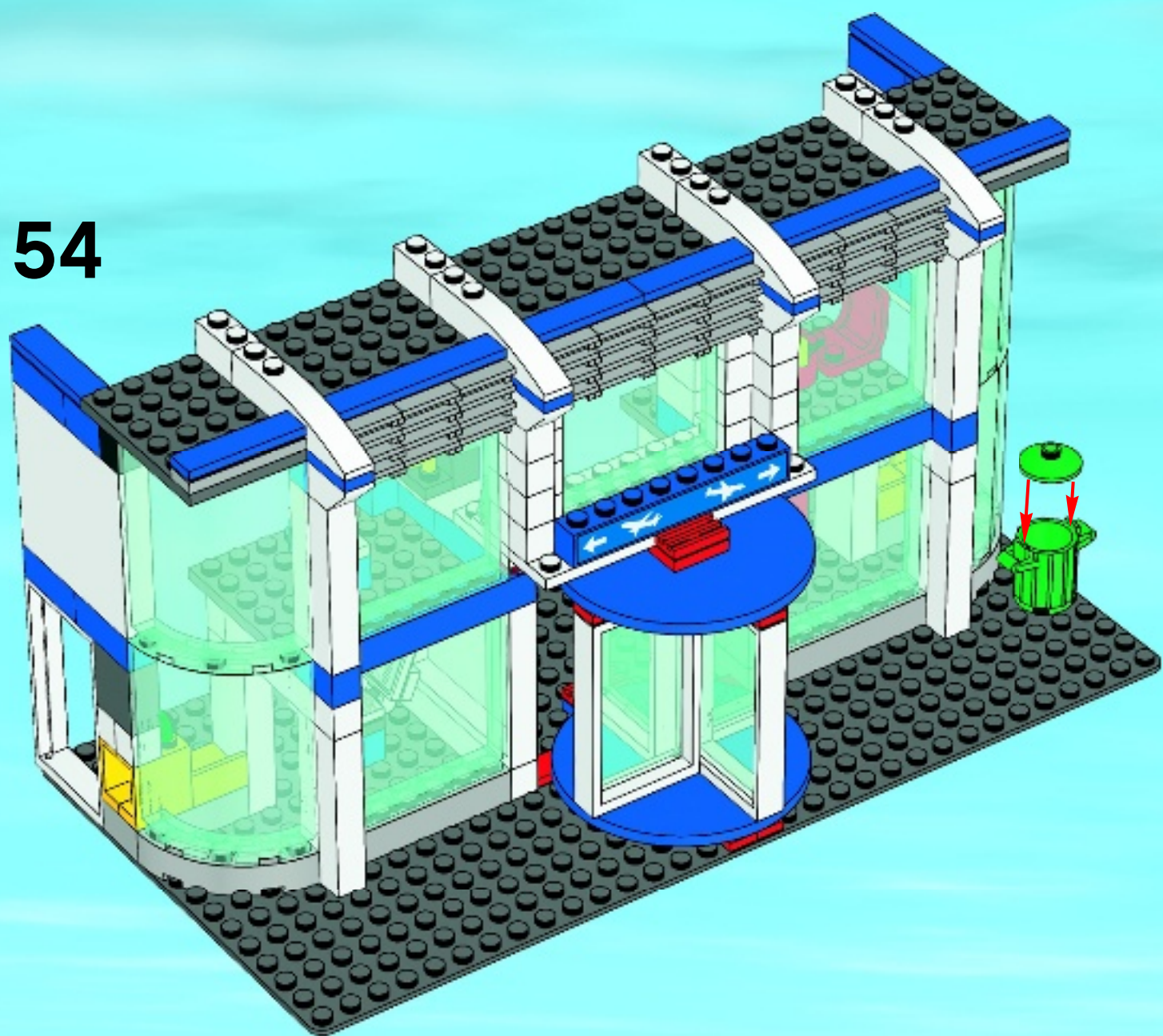

55

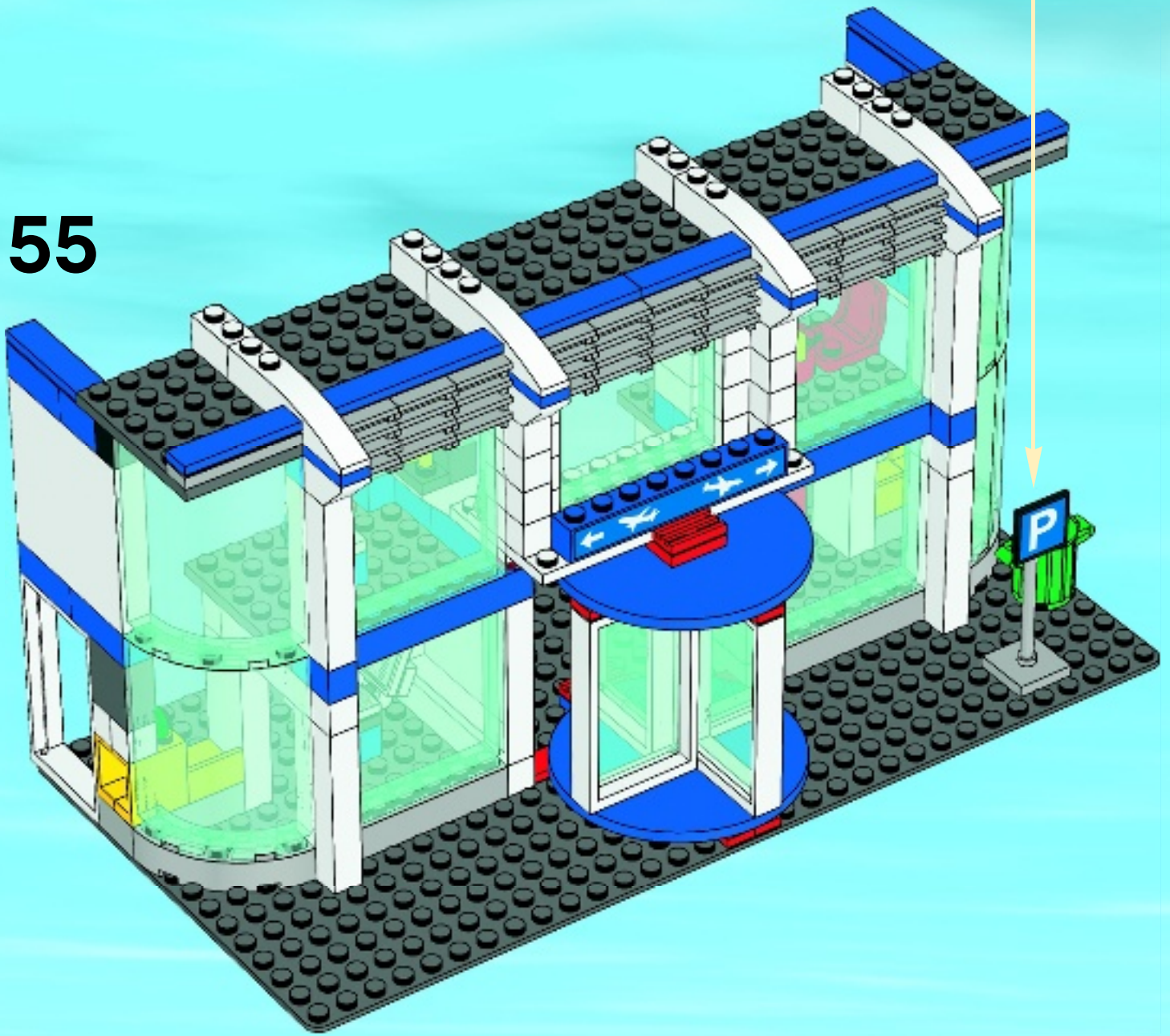
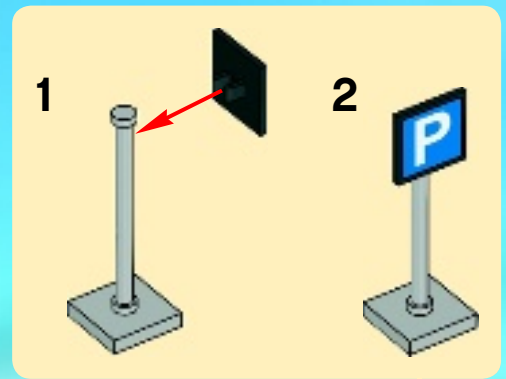

56

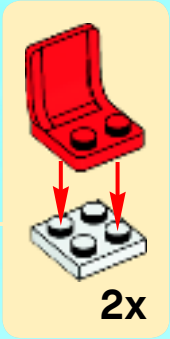
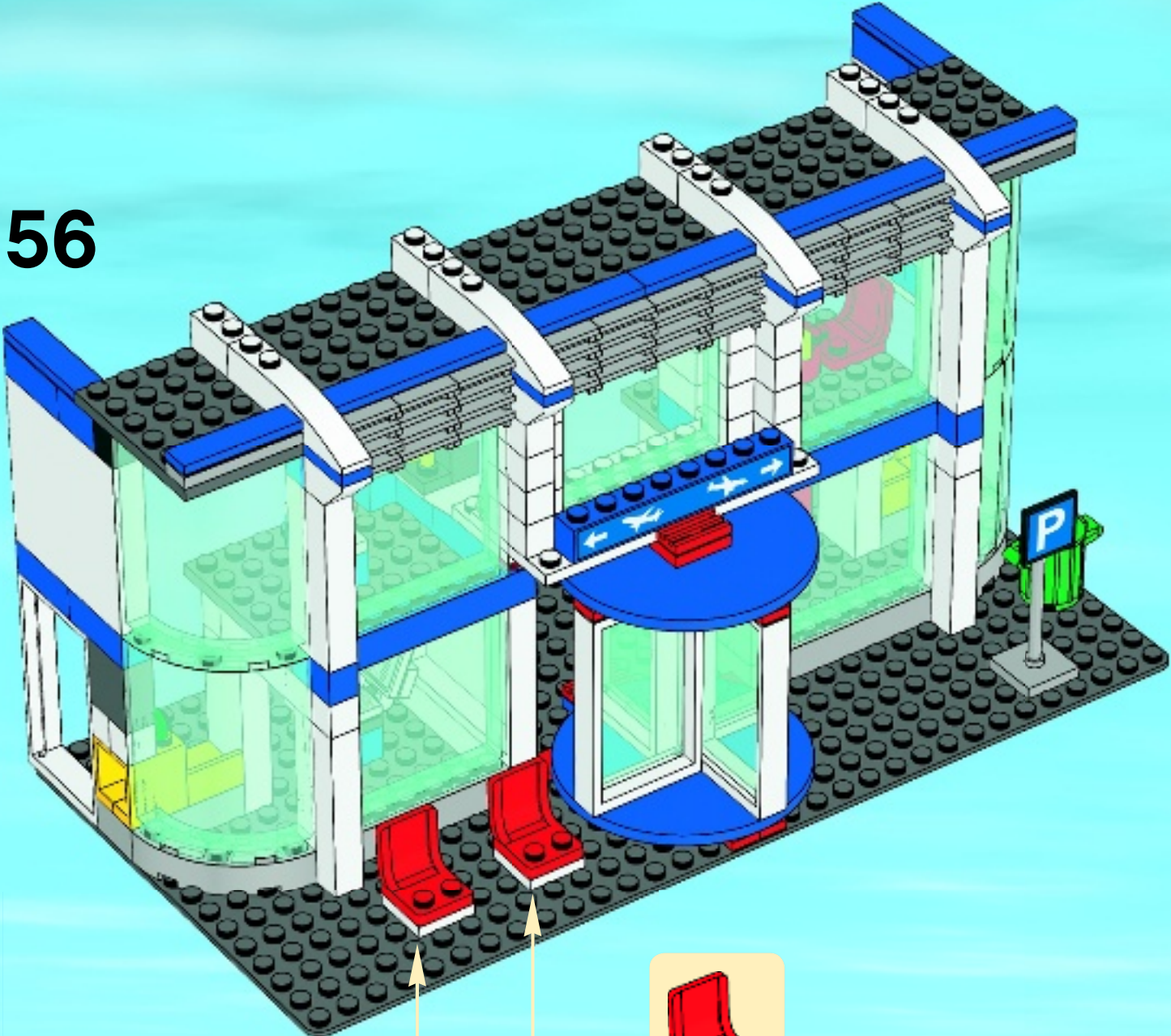

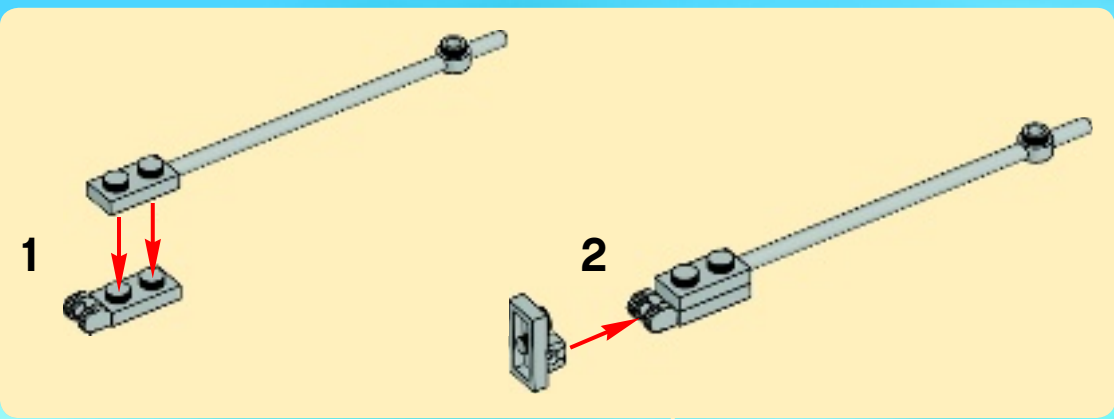

57

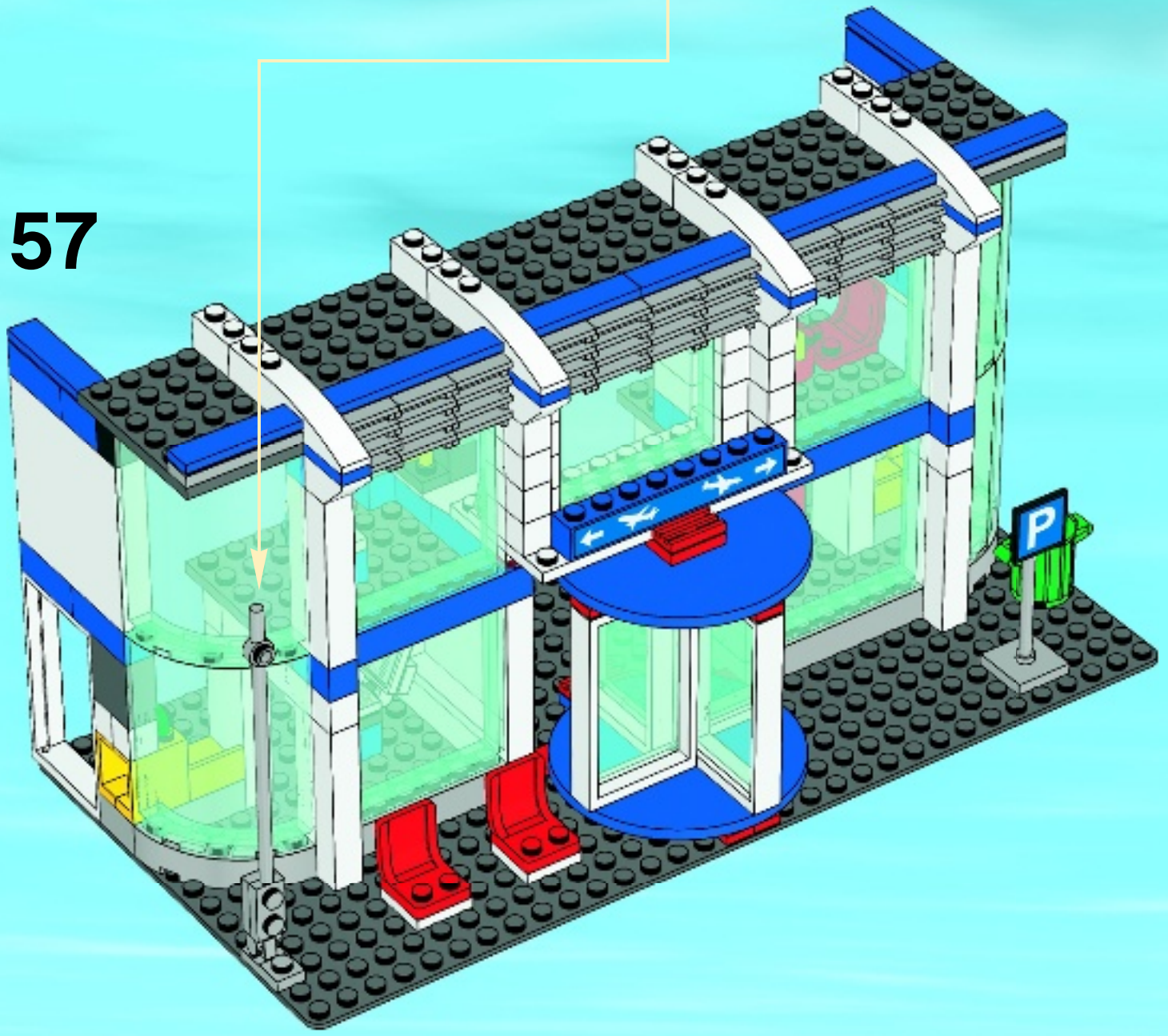

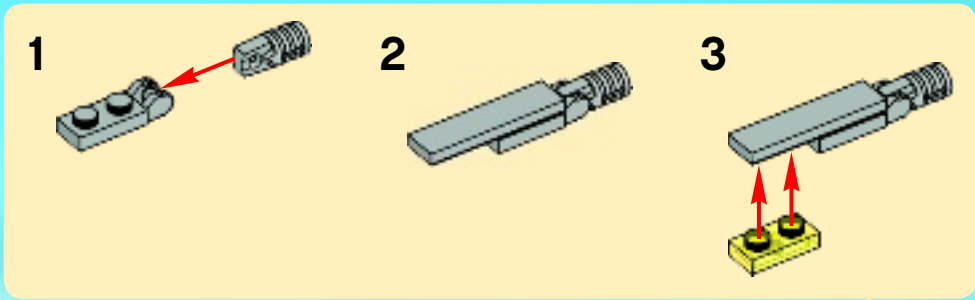

58

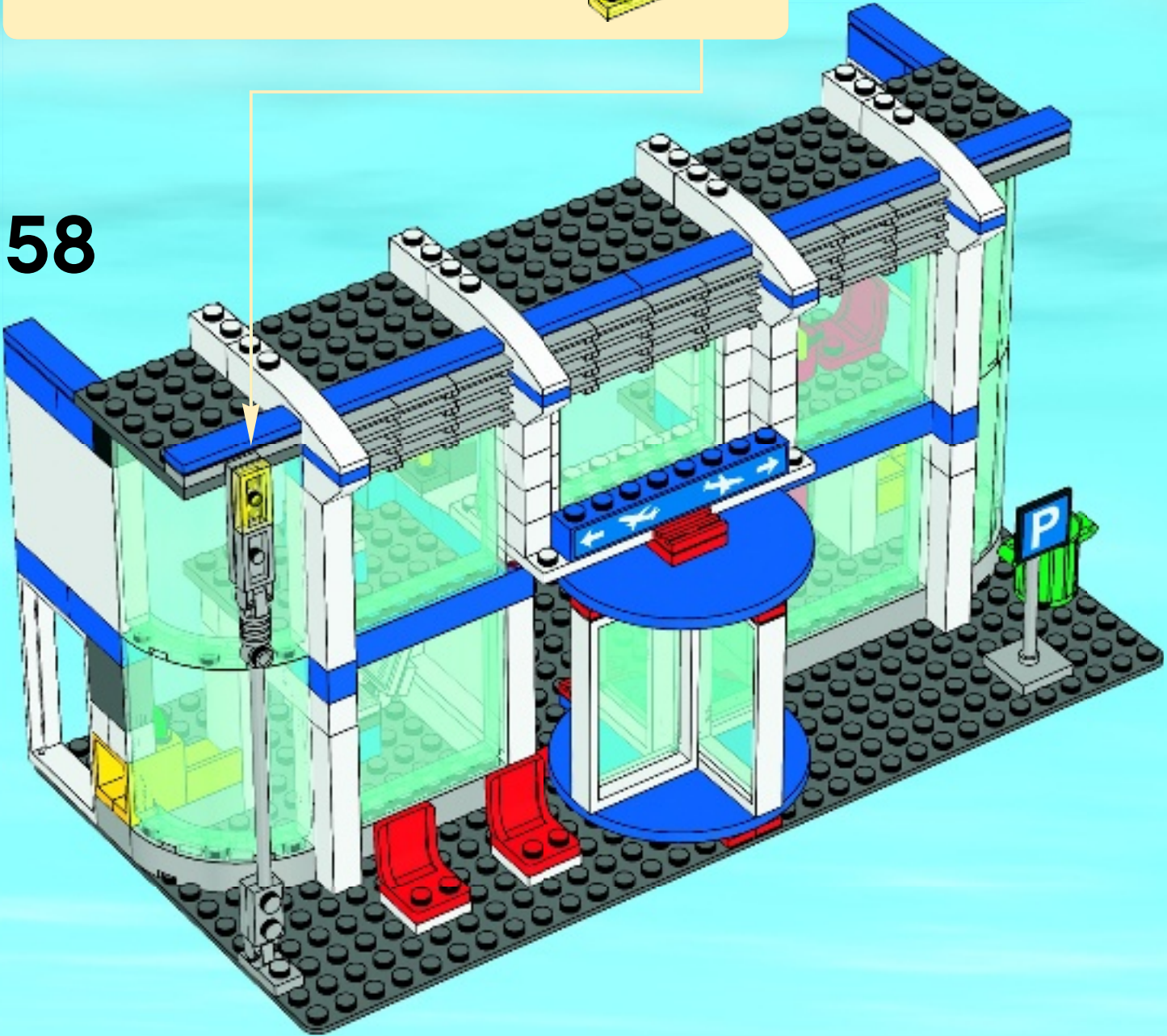

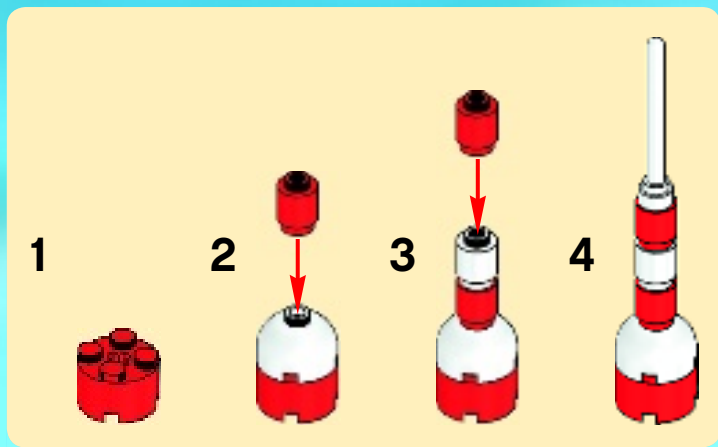

59

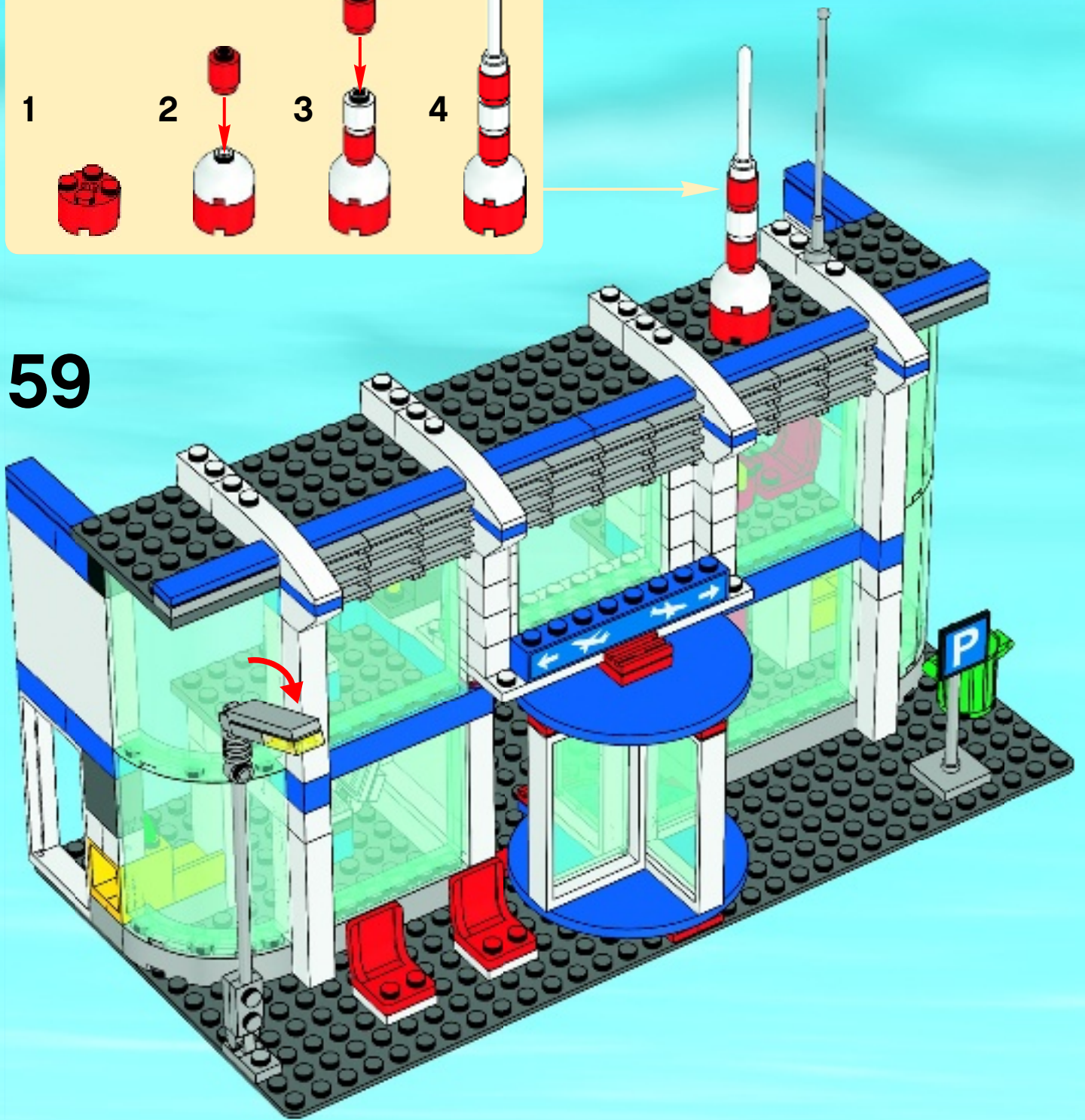

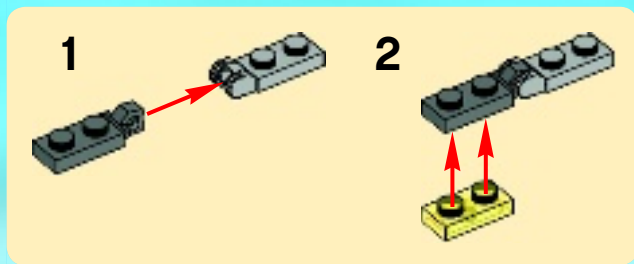

60

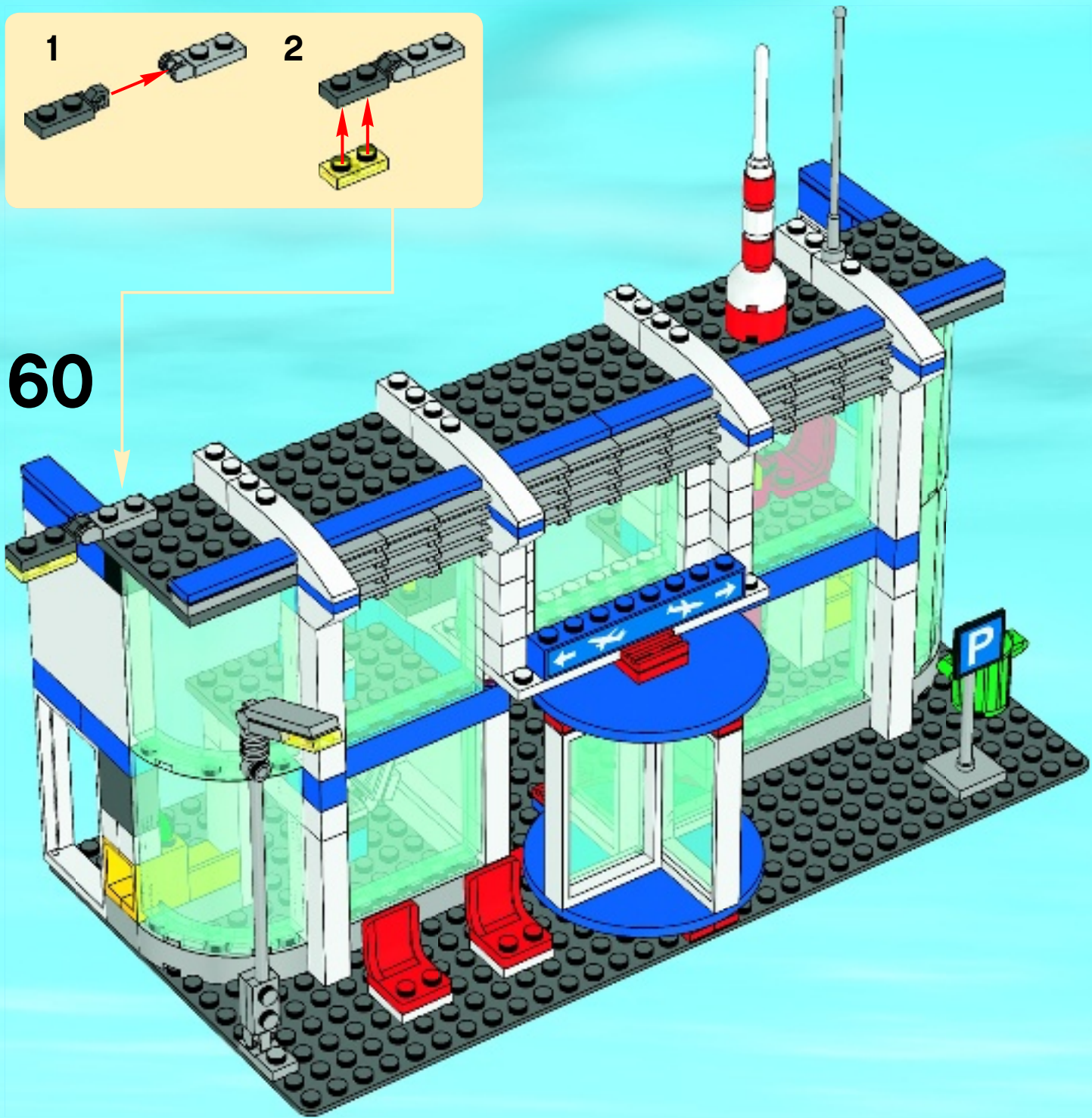

61

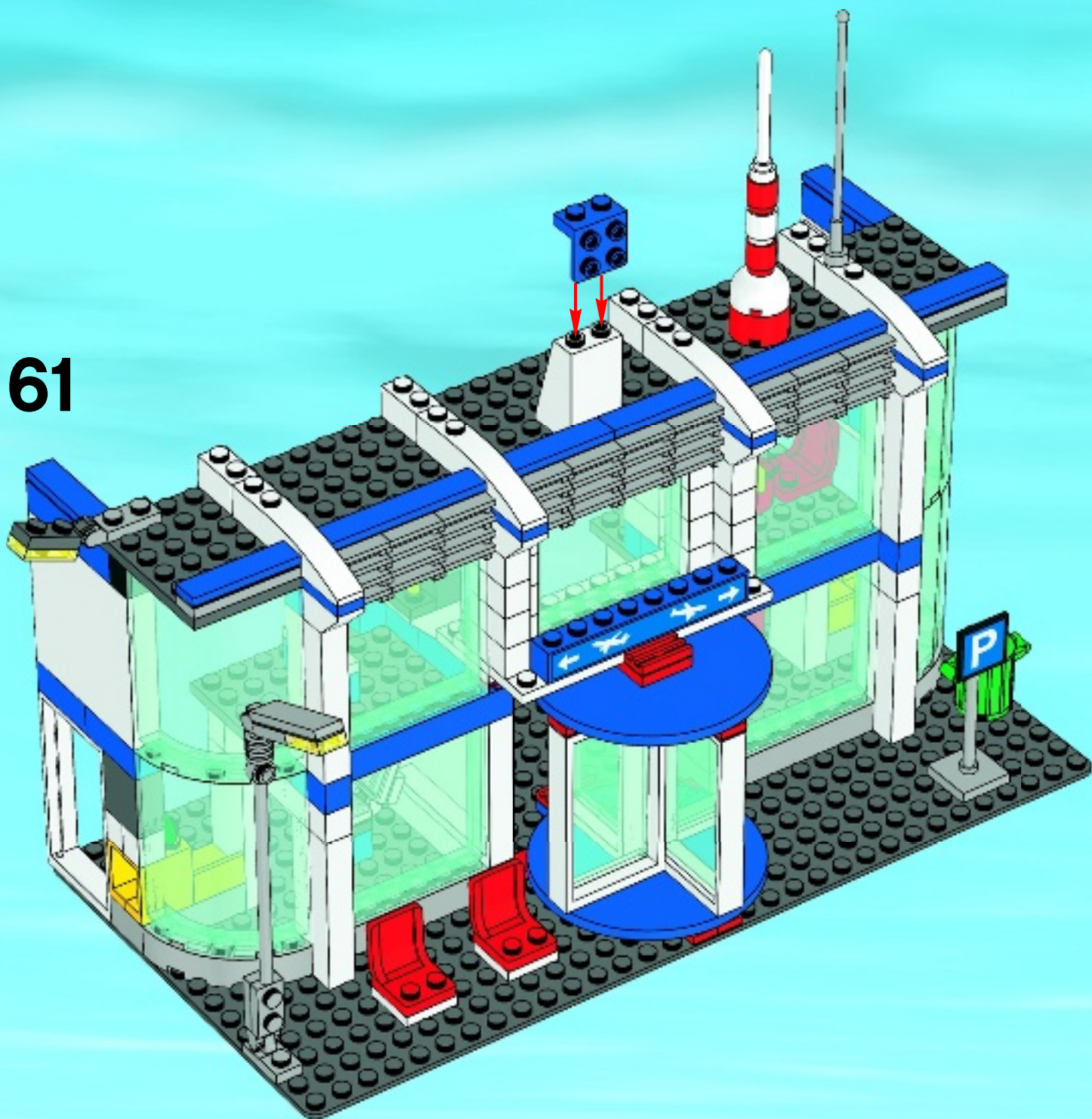

1

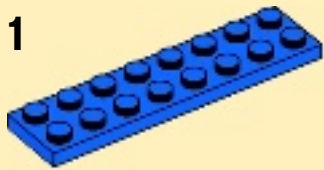

2

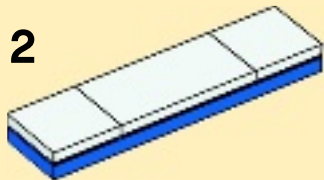

3



62

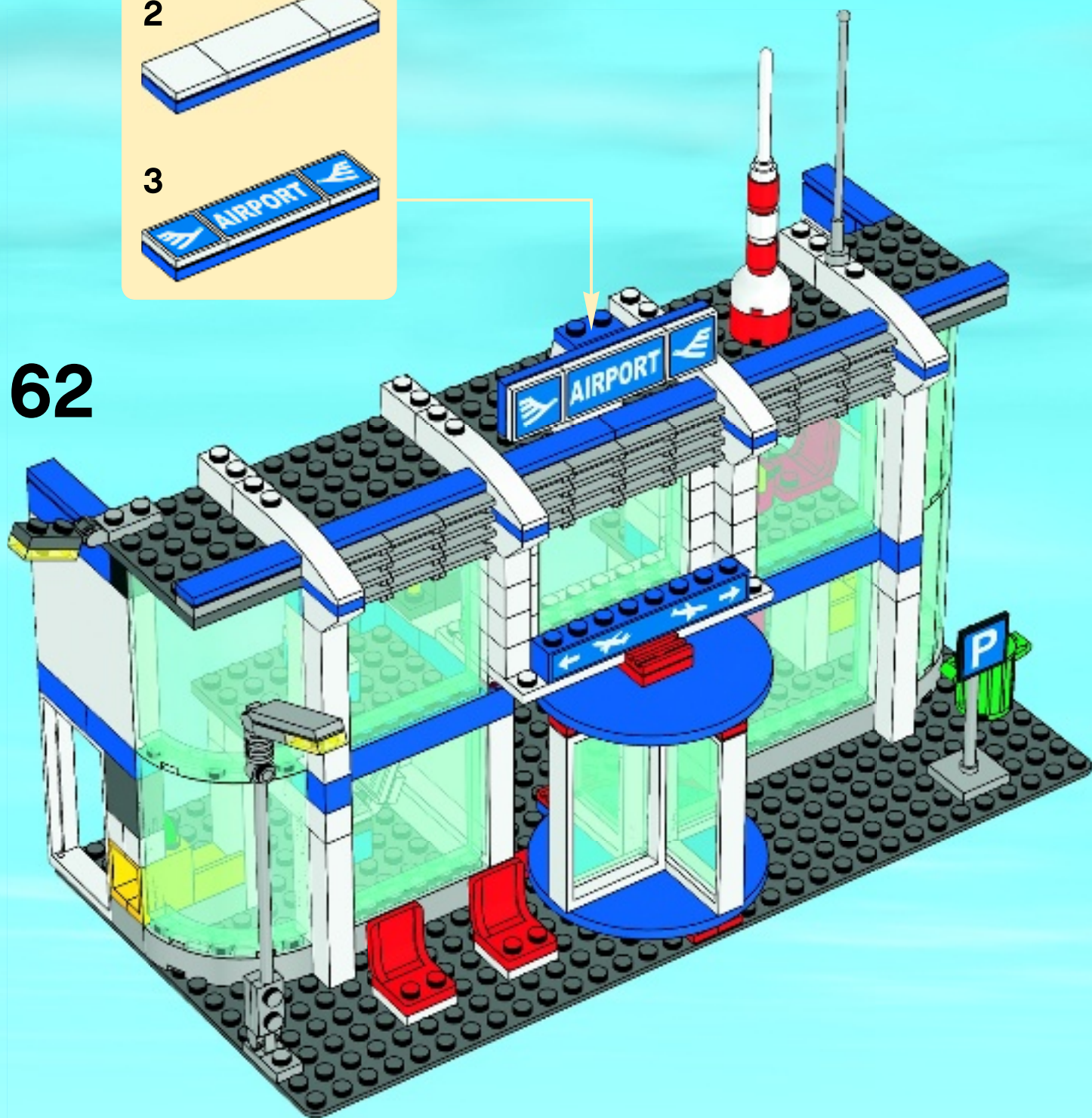

FREE! GRATIS! GRATUIT!



club
MAGAZINE™

www.LEGOclub.com



00800 5346 5555*

1-866-534-6258 • 1-877-518-5346

US & Canada only

Canada seulement

* FreePhone. Mobile charges may apply. * Numéro sans Frais. Des Frais peuvent s'appliquer avec les téléphones cellulaires. * Gebührenfrei, Kosten für Anrufe aus Mobilfunknetzen können abweichen.
* Gratis telefonnummer vanaf vaste lijn. * Des de ette gratis nummer, når du ringer fra PostTeleFon. * Det er gratis, når du ringer från en Post teleFon.



www.LEGO.com

VISIT THE WORLD'S
BIGGEST LEGO® SHOP!

www.LEGOshop.com

©2010 The LEGO Group. 4626125